

Solid state

SP4T RF Switch

ZSWA4-63DR+

50 Ω Absorptive RF switch 1 to 6000 MHz
Internal driver, Single Supply Voltage 2.3V to 3.6V

The Big Deal

- High isolation, 57 dB up to 2.7 GHz
- High linearity, IP3 +58 dBm at 1900 MHz
- High speed switching (320 ns)
- High power handling (+33 dBm)
- Low DC Voltage 2.3 to 3.6 V

Applications

- 3G/4G wireless infrastructure
- Automated Test equipment
- Switch matrices
- Defense

Product Overview

Mini-Circuits' ZSWA4-63DR+ is an SP4T absorptive, solid-state switch with an internal driver, designed for wideband operation from 1 MHz to 6 GHz supporting many applications requiring high performance from 3G/4G infrastructure to automated test equipment and various defense applications. The switch provides excellent isolation, fast switching speed and high linearity. It operates on a single 2.3 to 3.6V supply.

The switch comes housed in a rugged, compact, aluminum alloy case (2.00 x 1.5 x 0.6") with 5 SMA-F connectors at all RF ports and a 9-pin D-sub connector for DC power and control signals.



Case Style: QV2425

Connectors	Order P/N
SMA	ZSWA4-63DR+
	ZSWA4-63DRB+(with bracket)

RoHS Compliant

See our web site for RoHS Compliance methodologies and qualifications

Key Features

Feature	Advantages
Wideband, 1 to 6000 MHz	One model can be used in many applications, saving component count. Also ideal for wideband applications such as military and instrumentation.
Absorptive switch	In the off condition, RF output ports which are not switched ON are terminated into 50 Ω . This enables proper impedance termination of the circuitry following the RF output ports, preventing any unintended action such as oscillation.
High isolation, 58 dB @ 2700 MHz	High isolation significantly reduces leakage of power into OFF ports.
High linearity, <ul style="list-style-type: none">• +58 dBm IIP3• +97 dBm IIP2	High linearity minimizes unwanted intermodulation products which are difficult or impossible to filter in multi-carrier environments, or in the presence of strong interfering signal from adjacent circuitry or received by antenna.
Two or three pin control logic	Provides increased flexibility, allowing the model to be operated using two pin control, or three pin control if All Off state is required (RF COM not connected to any port).
Low operating power <ul style="list-style-type: none">• 2.3 to 3.6V• 0.1mA typ.	Allows the switch to be used in battery-operated systems

Electrical Specifications @ +25°C, Vdd=3.3V unless specified otherwise

Parameter	Port	Conditions	Min.	Typ.	Max.	Units	
Operating Frequency			1		6000	MHz	
Insertion Loss	RF COM to any active port	1-2700 MHz	-	1.3	2	dB	
		2700-5000 MHz	-	1.7	2.4		
		5000-6000 MHz	-	2.2	3		
Isolation ¹	Between ports RF1,RF2,RF3, and RF4 @ All states	1-1000 MHz	51	73	-	dB	
		1000-2700 MHz	43	57	-		
		2700-4000 MHz	37	48	-		
		4000-6000 MHz	26	36	-		
	RF COM to any terminated port @ All states	1-1000 MHz	55	80	-		
		1000-2700 MHz	44	58	-		
		2700-4000 MHz	37	45	-		
	RF COM to any terminated port	@ Active states	4000-6000 MHz	27	36		-
		@ All Off state	4000-6000 MHz	24	35		-
VSWR	RF COM port ^{2,3}	1-4000 MHz	-	1.25	-	:1	
		4000-6000 MHz	-	1.3	-		
	Any port connected to RF COM	1-4000 MHz	-	1.25	-		
		4000-6000 MHz	-	1.3	-		
	Any terminated port ³	1 to 6000 MHz	-	1.25	-		
Power Input @0.1 dB Compression ⁴	RF COM to any active port	900 MHz	-	+35	-	dBm	
IP2 ⁵	RF COM to any active port	1900 MHz		+97		dBm	
IP3 ⁵	RF COM to any active port	1900 MHz	-	+58	-	dBm	
Operating RF Input Power @ -40° to +85°	Any terminated (OFF) port ³	1-30 MHz	-	-	See figure 1	dBm	
		30-6000 MHz			+24		
	RF COM @ All Off state	1-30 MHz	-	-	See figure 1		
		30-6000 MHz			+24		
	Through path	1-30 MHz	-	-	See figure 1		
		30-6000 MHz			+33		

¹ See truth table on page 3 for list of states.

² VSWR defined for RF COM only at active state.

³ RF COM port is not terminated internally in All Off state.

⁴ Note absolute maximum ratings in table on page 3.

⁵ IP2 and IP3 are tested with +15 dBm per tone.

DC Electrical Specifications

Parameter	Min.	Typ.	Max.	Units
V _{DD} , Supply Voltage	2.3	—	3.6	V
Supply Current ⁶	—	0.1	0.4	mA
Control Voltage Low	0	—	0.2xVDD (max 0.6V)	V
Control Voltage High	0.8xVDD	—	5.5	V
Control Current (per pin)	—	0.015	—	mA

⁶ Supply current may reach 3 mA at startup

Switching Parameters

Parameter	Conditions	Min.	Typ.	Max.	Units
Switching time 50% trigger to 10/90% signal level	Pulse rate =12.5 kHz, RF freq. =501 MHz	—	320	400	ns
Video feedthrough @ all ports	V _{ctrl} =0/3V, Duty Cycle= 50%	—	0.1	—	mVpp
Non harmonic spur		—	-120	—	dBm
Switching frequency		—	—	12.5	kHz

Absolute Maximum Ratings ^{7,8}

Operating Temperature	-40°C to 85°C
Storage Temperature	-55°C to 100°C
Vdd, supply voltage.	-5V to 3.6V
Control voltage	-0.3V to 5.5V
RF input power 1-30 MHz	See Figure 1
RF input power 30-6000 MHz	+34 dBm
DC voltage @ RF Ports	8V
ESD @ (HBM) D-SUB pins	1.5kV
ESD @ (HBM) RF ports	4kV

⁷. Operation of this device above any of these conditions may cause permanent damage.

⁸. Operation in the range between the max operating power and the absolute maximum rating for extended periods of time may result in reduced life and reliability.

Truth Table ^{9,10}

State	V3	V2	V1	RF COM-RF1	RF COM-RF2	RF COM-RF3	RF COM-RF4
1	Low	Low	Low	OFF	OFF	OFF	ON
2	Low	Low	High	ON	OFF	OFF	OFF
3	Low	High	Low	OFF	ON	OFF	OFF
4	Low	High	High	OFF	OFF	ON	OFF
5	High	Low	Low	OFF	OFF	OFF	ON
6	High	Low	High	All Off (disconnected state)			
7	High	High	Low	All Off (disconnected state)			
8	High	High	High	Unsupported			

⁹. All controls have internal 100 kΩ pull down resistor.

¹⁰. For two pin logic use V1 & V2 with V3 either open or GND.

Simplified Schematic

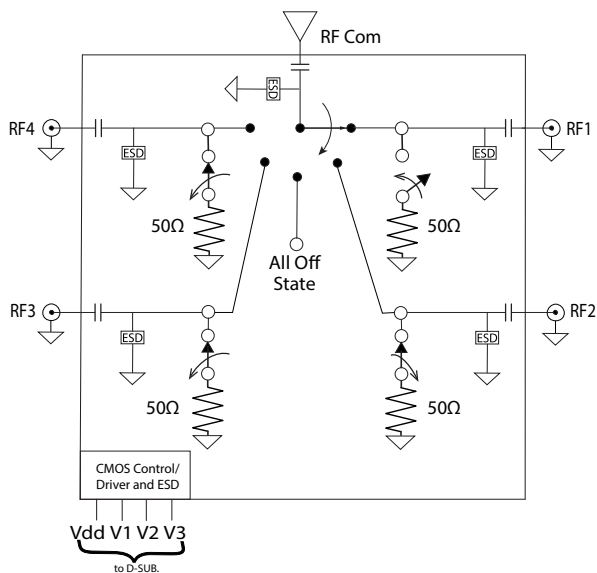

Maximum Power at low frequency

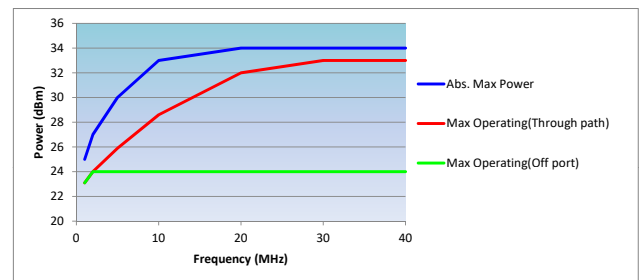
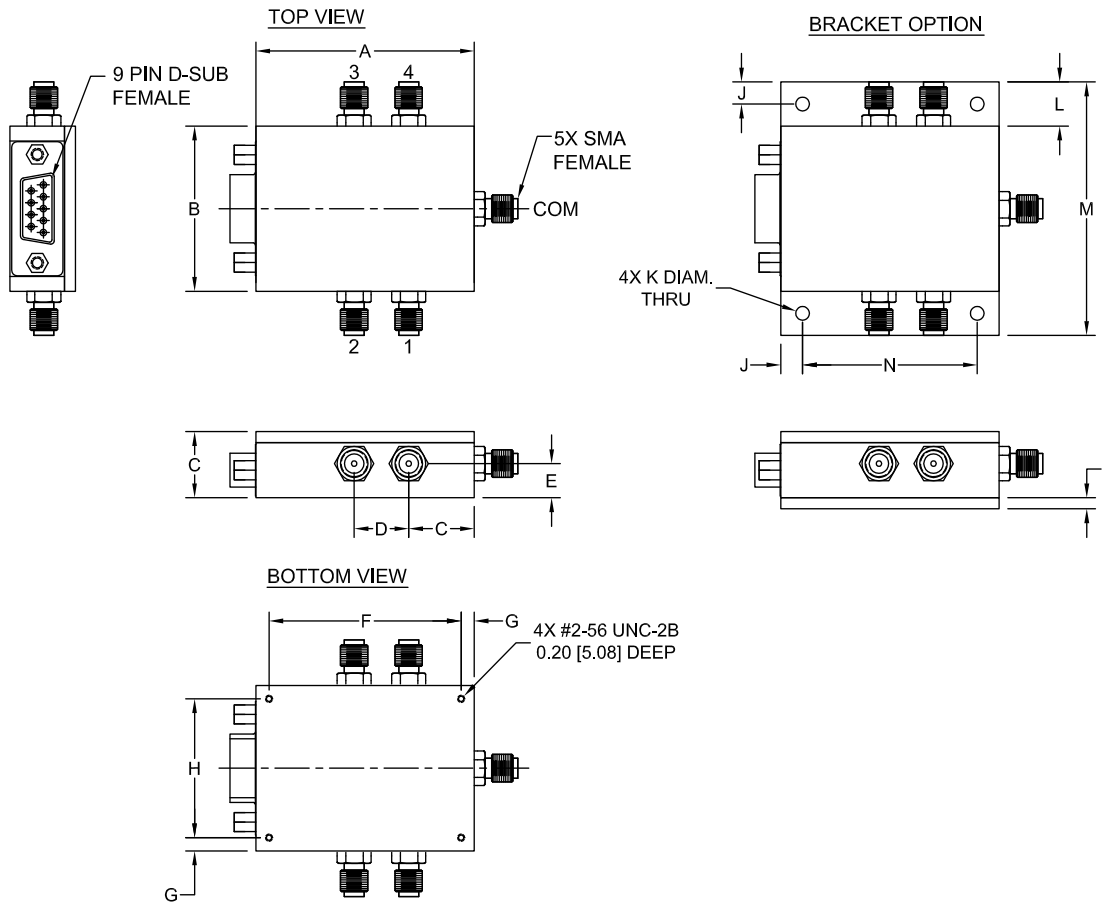

Figure 1

Outline Drawing (QV2425)



Outline Dimensions ($\frac{\text{inch}}{\text{mm}}$)

A	B	C	D	E	F	G	H	J	K	L	M	N	P	WT. GRAMS
2.00	1.50	.60	.500	.31	1.760	.120	1.260	.200	.125	.40	2.30	1.600	.100	70
50.8	38.1	15.24	12.7	7.87	44.7	3.05	32.0	5.08	3.18	10.16	58.4	40.64	2.54	

Connections

RF ports (RF1, RF2, RF3, RF4, RF COM)	(SMA female)
Supply & control port*	(9 pin D-Sub female)

*9 Pin D-Sub Pin Connections

PIN Number	Function
1	NC
2	V3
3	V2
4	V1
5	Vdd
6 - 9	GND ¹¹

¹¹. Only one of the GND pins is required for proper operation

Typical Performance Curves

Insertion Loss over Temperature

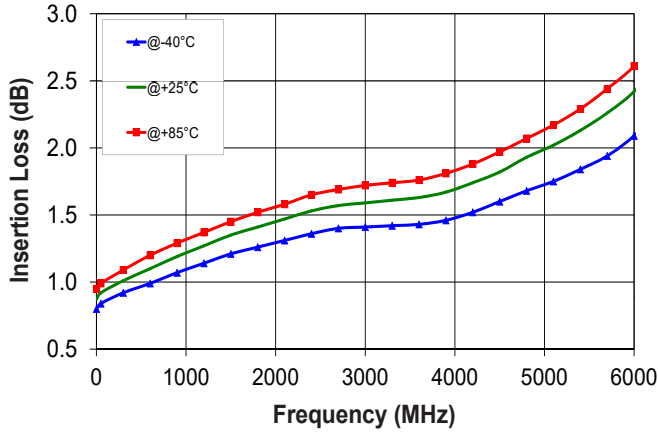

Insertion Loss at RF1- RF4 vs. Frequency

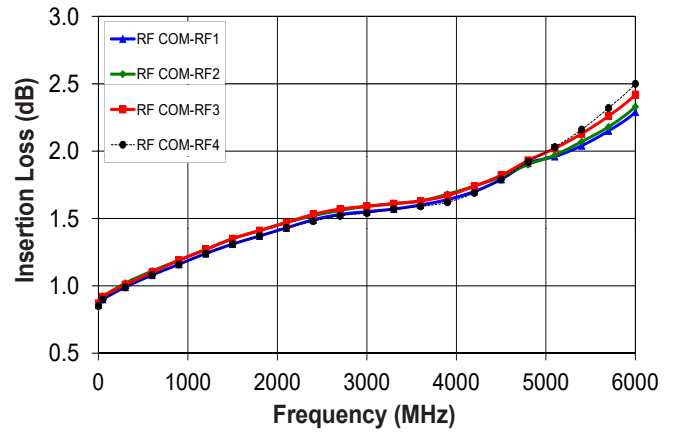

Isolation RF Com to RF1 with RF4 active

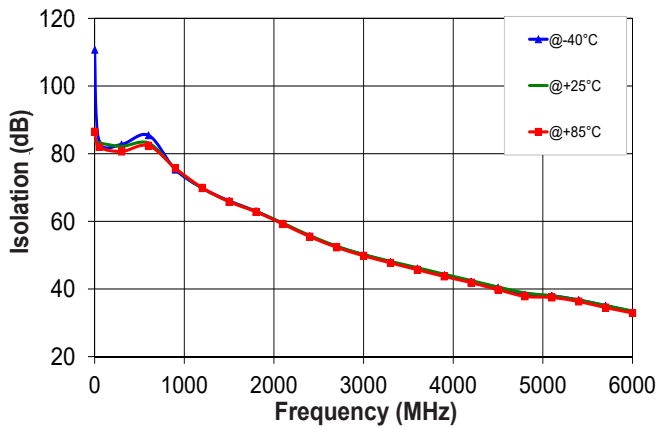

Isolation RF Com to RF4 with RF3 active

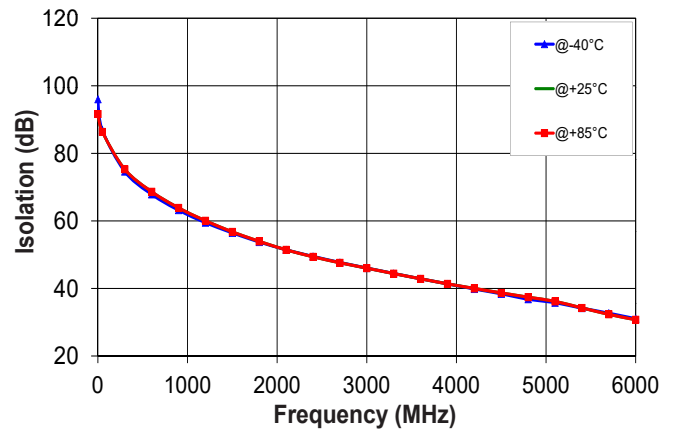

Isolation RF COM to RF4 at All Off State

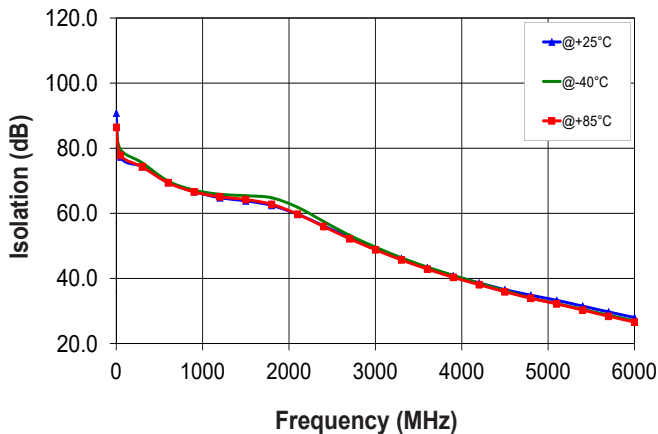

Isolation at All Off State

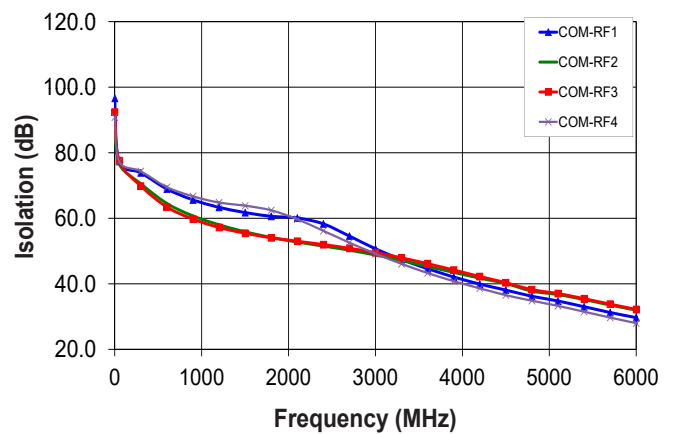

Typical Performance Curves (Continued)

Isolation RF2 to RF3 with RF3 active

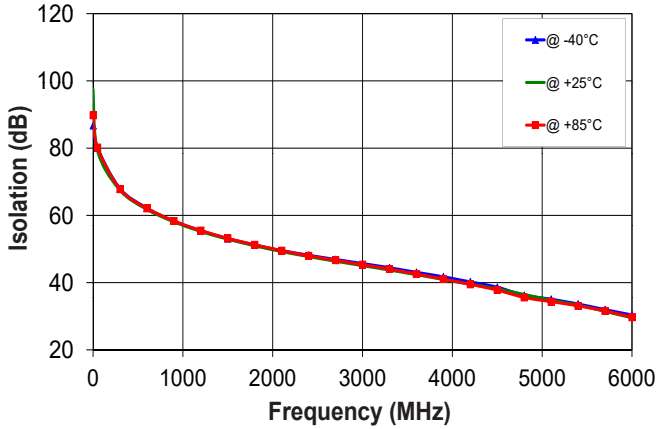

Isolation RF1 to RF4 with RF1 active

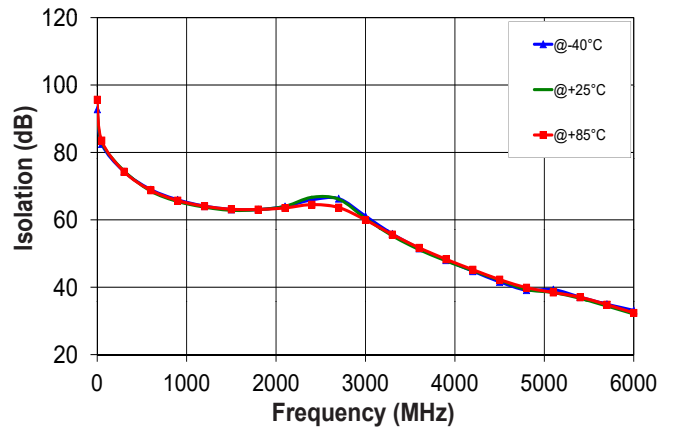

Isolation RF2 to RF3 with RF4 active

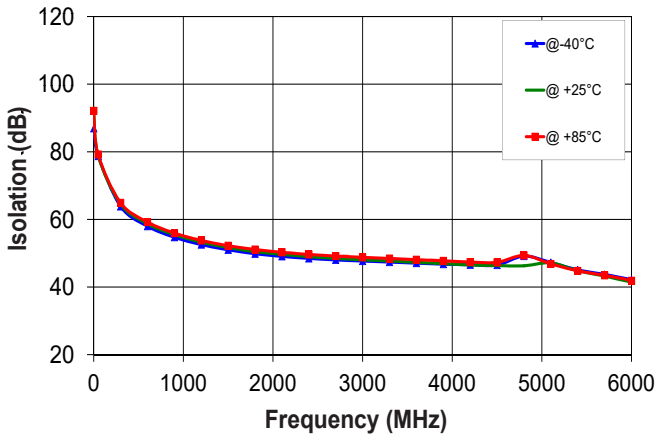

Isolation RF2 to RF4 with RF1 active

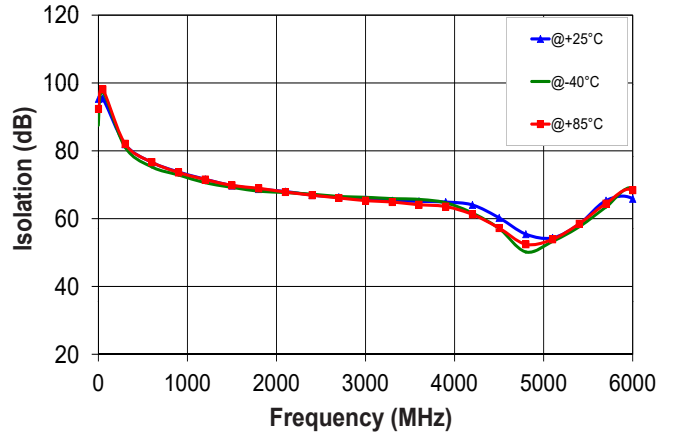

VSWR RF Com over Temperature

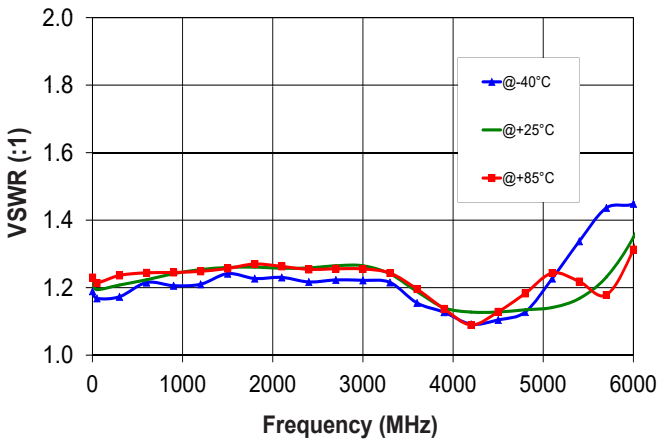

VSWR RF Com vs Frequency

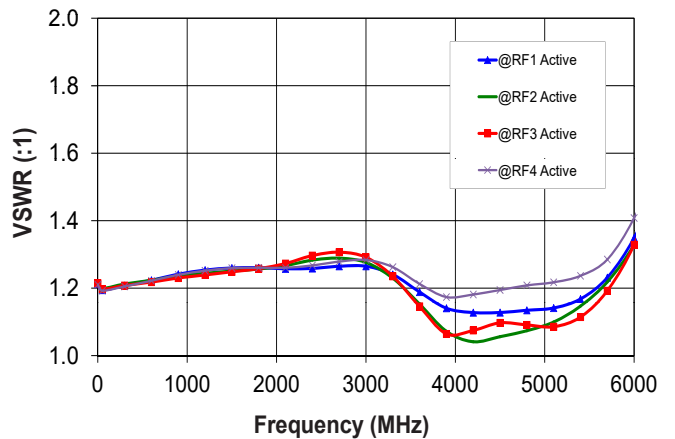

Typical Performance Curves (Continued)

VSWR active Port over Temperature

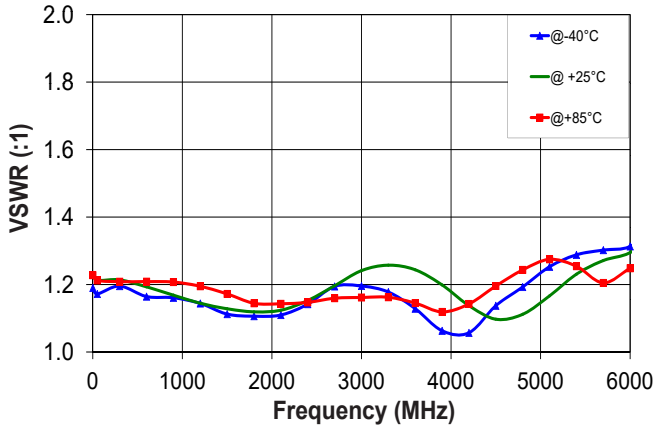

VSWR active Port vs Frequency

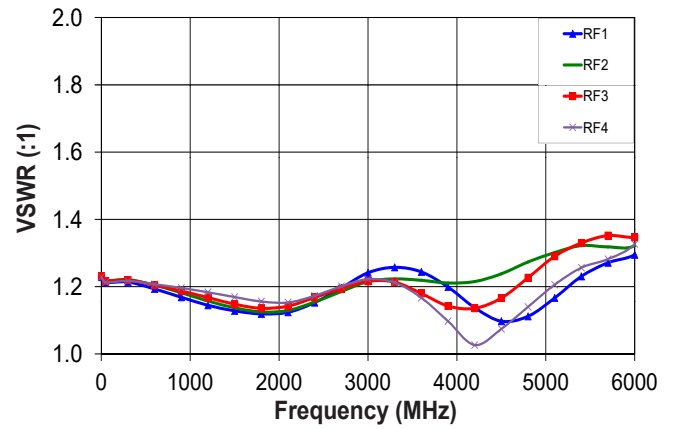

VSWR internal Term. over Temperature

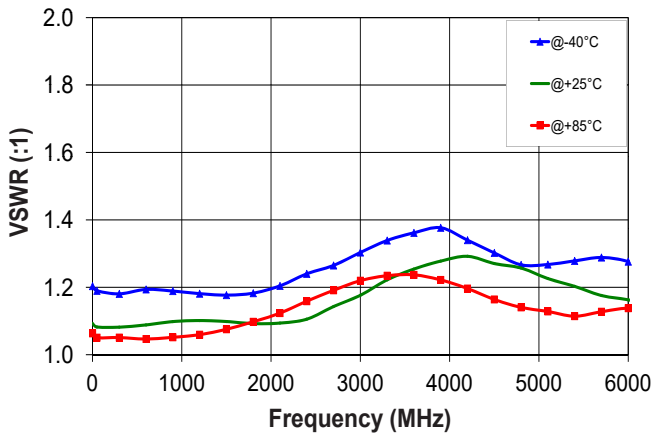

VSWR terminated port vs. Frequency

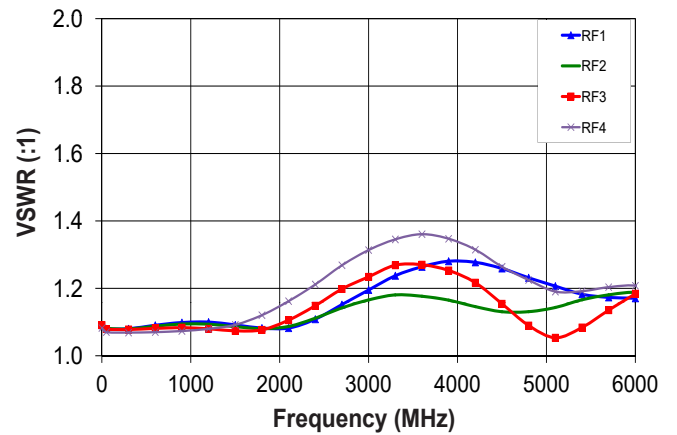

RF SP4T Switch

ZSWA4-63DR+

Typical Performance Data

TEST CONDITIONS: @Temperature = -40degC

Power In = 0dBm

FREQUENCY (MHz)	INSERTION LOSS (dB)				ISOLATION (dB)				
	COM-RF1	COM-RF2	COM-RF3	COM-RF4	COM-RF1	COM-RF4	RF2-RF3	RF1-RF4	RF2-RF3
					(RF4 Active)	(RF3 Active)	(RF3 Active)	(RF1 Active)	(RF4 Active)
1	0.77	0.80	0.80	0.79	110.76	96.02	86.74	92.81	86.94
10	0.79	0.82	0.82	0.80	87.41	88.59	87.40	87.91	89.70
50	0.81	0.84	0.84	0.83	83.57	86.92	80.06	82.52	78.73
100	0.84	0.87	0.87	0.86	82.02	83.97	76.06	83.07	72.82
200	0.87	0.91	0.91	0.89	82.11	78.12	71.18	77.51	67.14
300	0.88	0.92	0.92	0.90	82.74	74.61	67.96	74.31	63.83
400	0.90	0.94	0.94	0.92	84.77	71.77	65.62	71.92	61.35
500	0.92	0.97	0.97	0.95	88.18	69.65	63.74	70.15	59.47
700	0.97	1.02	1.02	0.99	81.84	66.06	60.66	67.77	56.70
1000	1.04	1.09	1.10	1.06	73.11	61.81	57.25	65.12	53.91
1100	1.05	1.11	1.12	1.08	71.37	60.63	56.34	64.58	53.19
1200	1.07	1.13	1.14	1.11	69.84	59.49	55.44	64.09	52.56
1300	1.09	1.15	1.16	1.13	68.48	58.38	54.63	63.75	52.00
1400	1.12	1.18	1.19	1.15	67.30	57.34	53.87	63.38	51.49
1500	1.14	1.20	1.21	1.17	66.05	56.45	53.12	63.12	51.02
1600	1.16	1.22	1.23	1.19	65.14	55.48	52.36	62.97	50.57
1700	1.17	1.24	1.24	1.21	64.03	54.59	51.81	62.93	50.20
1800	1.19	1.26	1.26	1.22	62.99	53.75	51.19	63.05	49.86
1900	1.20	1.27	1.28	1.23	61.81	52.92	50.59	63.23	49.58
2000	1.22	1.29	1.29	1.25	60.63	52.18	50.05	63.43	49.33
2100	1.24	1.31	1.31	1.27	59.37	51.45	49.53	63.96	49.07
2200	1.26	1.33	1.33	1.29	58.16	50.75	49.02	64.41	48.86
2400	1.28	1.35	1.36	1.31	55.66	49.49	48.14	65.93	48.47
2500	1.30	1.37	1.38	1.32	54.52	48.87	47.70	66.60	48.32
2600	1.31	1.38	1.39	1.33	53.48	48.29	47.27	66.87	48.17
2700	1.32	1.39	1.40	1.34	52.55	47.71	46.88	66.31	48.03
2800	1.32	1.40	1.40	1.35	51.68	47.15	46.48	64.68	47.92
3000	1.33	1.41	1.41	1.36	50.11	46.05	45.67	61.12	47.69
3200	1.34	1.42	1.42	1.37	48.70	44.96	44.84	57.57	47.50
3400	1.35	1.43	1.43	1.38	47.36	43.90	43.98	54.32	47.29
3600	1.36	1.44	1.43	1.39	46.07	42.86	43.06	51.53	47.08
3800	1.38	1.46	1.45	1.41	44.76	41.85	42.18	49.16	46.87
4000	1.40	1.48	1.48	1.42	43.47	40.88	41.25	46.93	46.69
4200	1.43	1.52	1.52	1.46	42.20	39.85	40.22	44.78	46.61
4400	1.47	1.56	1.57	1.51	40.99	38.93	39.18	42.66	46.45
4600	1.54	1.61	1.63	1.59	39.53	37.87	37.81	40.63	46.53
4800	1.61	1.66	1.68	1.69	38.34	36.82	36.20	39.15	49.16
5000	1.65	1.71	1.74	1.75	38.28	36.13	35.38	39.48	48.67
5200	1.67	1.73	1.78	1.80	37.64	35.34	34.56	38.52	46.26
5300	1.68	1.76	1.81	1.84	37.22	34.73	34.11	37.76	45.65
5400	1.71	1.79	1.84	1.88	36.73	34.18	33.62	37.08	45.08
5500	1.74	1.81	1.87	1.92	36.20	33.64	33.08	36.33	44.59
5600	1.76	1.84	1.90	1.96	35.62	33.17	32.55	35.63	44.17
5700	1.79	1.88	1.94	2.01	35.07	32.68	31.96	34.95	43.73
5800	1.83	1.92	1.98	2.05	34.52	32.14	31.43	34.38	43.27
5900	1.87	1.96	2.03	2.10	33.95	31.58	30.86	33.74	42.75
6000	1.92	2.02	2.09	2.17	33.32	31.04	30.36	33.12	42.22
6100	1.98	2.08	2.15	2.25	32.77	30.53	29.85	32.47	41.70
6200	2.06	2.16	2.23	2.34	32.20	29.97	29.35	31.80	41.26
6300	2.14	2.22	2.30	2.43	31.65	29.44	28.82	31.03	40.88
6400	2.24	2.30	2.38	2.54	31.11	28.86	28.32	30.27	40.60
6600	2.44	2.47	2.56	2.77	30.23	27.76	27.16	28.62	40.04
6800	2.71	2.69	2.80	3.05	29.30	26.70	25.98	26.99	39.60
7000	3.04	2.95	3.11	3.42	28.64	25.76	24.77	25.37	39.25

Notes

- A. Performance and quality attributes and conditions not expressly stated in this specification document are intended to be excluded and do not form a part of this specification document.
- B. Electrical specifications and performance data contained in this specification document are based on Mini-Circuits' applicable established test performance criteria and measurement instructions.
- C. The parts covered by this specification document are subject to Mini-Circuits standard limited warranty and terms and conditions (collectively, "Standard Terms"). Purchasers of this part are entitled to the rights and benefits contained therein. For a full statement of the Standard Terms and the exclusive rights and remedies thereunder, please visit Mini-Circuits' website at www.minicircuits.com/MCStore/terms.jsp



RF SP4T Switch

ZSWA4-63DR+

Typical Performance Data

TEST CONDITIONS: @Temperature = -40degC

Power In = 0dBm

FREQUENCY (MHz)	VSWR								Off (terminated) State VSWR			
	(:1)								(:1)			
	COM RF1 Active	COM RF2 Active	COM RF3 Active	COM RF4 Active	RF1 RF1 Active	RF2 RF2 Active	RF3 RF3 Active	RF4 RF4 Active	RF1	RF2	RF3	RF4
1	1.20	1.20	1.22	1.23	1.20	1.21	1.20	1.20	1.28	1.29	1.29	1.28
10	1.18	1.18	1.20	1.21	1.18	1.19	1.19	1.18	1.28	1.28	1.29	1.27
50	1.18	1.19	1.20	1.22	1.18	1.19	1.19	1.19	1.27	1.28	1.28	1.26
100	1.19	1.19	1.20	1.22	1.19	1.20	1.20	1.19	1.26	1.27	1.26	1.25
200	1.19	1.19	1.21	1.22	1.20	1.21	1.20	1.19	1.26	1.26	1.27	1.26
300	1.18	1.19	1.21	1.24	1.20	1.21	1.20	1.20	1.27	1.27	1.28	1.27
400	1.19	1.20	1.22	1.25	1.19	1.20	1.20	1.20	1.27	1.28	1.27	1.27
500	1.20	1.21	1.22	1.25	1.18	1.19	1.19	1.18	1.28	1.28	1.27	1.27
700	1.22	1.22	1.23	1.25	1.17	1.18	1.18	1.18	1.27	1.27	1.26	1.26
1000	1.23	1.23	1.24	1.24	1.15	1.16	1.16	1.15	1.28	1.27	1.26	1.26
1100	1.23	1.23	1.24	1.24	1.14	1.16	1.15	1.14	1.27	1.27	1.26	1.27
1200	1.23	1.23	1.24	1.24	1.13	1.15	1.14	1.13	1.28	1.28	1.27	1.28
1300	1.23	1.23	1.25	1.24	1.13	1.14	1.14	1.13	1.28	1.28	1.27	1.28
1400	1.23	1.23	1.25	1.25	1.12	1.13	1.13	1.12	1.28	1.28	1.27	1.28
1500	1.24	1.23	1.25	1.26	1.11	1.12	1.12	1.11	1.27	1.28	1.26	1.28
1600	1.23	1.23	1.25	1.26	1.10	1.12	1.11	1.11	1.26	1.27	1.26	1.28
1700	1.23	1.23	1.25	1.27	1.10	1.12	1.11	1.11	1.25	1.27	1.26	1.27
1800	1.22	1.23	1.26	1.27	1.10	1.11	1.11	1.10	1.25	1.26	1.26	1.27
1900	1.21	1.23	1.26	1.27	1.11	1.12	1.11	1.10	1.24	1.26	1.26	1.27
2000	1.22	1.23	1.26	1.26	1.11	1.12	1.10	1.09	1.24	1.25	1.27	1.27
2100	1.23	1.25	1.27	1.28	1.11	1.12	1.11	1.10	1.23	1.25	1.28	1.28
2200	1.23	1.25	1.27	1.27	1.11	1.13	1.12	1.10	1.22	1.25	1.29	1.29
2400	1.23	1.27	1.28	1.27	1.15	1.16	1.15	1.14	1.23	1.27	1.31	1.31
2500	1.24	1.27	1.29	1.26	1.17	1.18	1.16	1.16	1.24	1.28	1.33	1.32
2600	1.24	1.27	1.29	1.27	1.19	1.19	1.18	1.18	1.26	1.29	1.36	1.35
2700	1.25	1.28	1.29	1.28	1.21	1.20	1.19	1.19	1.28	1.30	1.38	1.37
2800	1.24	1.27	1.29	1.27	1.21	1.20	1.19	1.19	1.30	1.32	1.39	1.39
3000	1.24	1.25	1.28	1.27	1.22	1.19	1.19	1.19	1.35	1.36	1.43	1.44
3200	1.23	1.22	1.25	1.26	1.22	1.18	1.17	1.19	1.40	1.38	1.45	1.47
3400	1.21	1.19	1.21	1.23	1.20	1.16	1.15	1.17	1.42	1.39	1.44	1.49
3600	1.17	1.15	1.15	1.17	1.17	1.13	1.12	1.13	1.46	1.39	1.44	1.52
3800	1.17	1.12	1.10	1.12	1.15	1.12	1.08	1.11	1.48	1.40	1.42	1.52
4000	1.15	1.08	1.05	1.06	1.09	1.09	1.05	1.07	1.50	1.39	1.39	1.51
4200	1.12	1.03	1.04	1.02	1.04	1.12	1.08	1.06	1.49	1.35	1.35	1.49
4400	1.11	1.02	1.05	1.05	1.01	1.16	1.13	1.07	1.48	1.34	1.30	1.46
4600	1.10	1.06	1.06	1.10	1.06	1.21	1.18	1.11	1.46	1.31	1.27	1.44
4800	1.10	1.11	1.07	1.14	1.10	1.25	1.21	1.13	1.44	1.29	1.24	1.42
5000	1.12	1.16	1.09	1.13	1.16	1.30	1.27	1.18	1.39	1.26	1.22	1.40
5200	1.18	1.21	1.11	1.15	1.23	1.33	1.32	1.24	1.36	1.29	1.24	1.38
5300	1.21	1.24	1.13	1.16	1.26	1.34	1.33	1.25	1.36	1.28	1.25	1.40
5400	1.24	1.27	1.15	1.14	1.29	1.34	1.34	1.28	1.36	1.25	1.26	1.40
5500	1.27	1.30	1.17	1.15	1.31	1.35	1.34	1.30	1.34	1.24	1.27	1.40
5600	1.30	1.31	1.19	1.16	1.32	1.35	1.34	1.31	1.33	1.27	1.29	1.42
5700	1.33	1.33	1.22	1.17	1.32	1.33	1.35	1.33	1.31	1.28	1.29	1.42
5800	1.36	1.33	1.24	1.23	1.33	1.32	1.34	1.34	1.30	1.28	1.30	1.40
5900	1.39	1.36	1.28	1.29	1.33	1.30	1.33	1.34	1.29	1.27	1.33	1.40
6000	1.38	1.36	1.33	1.34	1.31	1.29	1.32	1.34	1.27	1.25	1.34	1.40
6100	1.40	1.36	1.38	1.37	1.31	1.28	1.31	1.36	1.26	1.26	1.34	1.40
6200	1.46	1.38	1.43	1.43	1.33	1.29	1.31	1.31	1.25	1.27	1.34	1.39
6300	1.50	1.42	1.50	1.50	1.34	1.30	1.31	1.42	1.25	1.29	1.35	1.38
6400	1.55	1.46	1.56	1.61	1.36	1.32	1.31	1.45	1.24	1.30	1.34	1.36
6600	1.68	1.57	1.69	1.81	1.41	1.35	1.30	1.52	1.22	1.29	1.33	1.30
6800	1.92	1.75	1.85	1.94	1.49	1.39	1.31	1.62	1.21	1.29	1.31	1.21
7000	2.23	2.07	2.04	2.17	1.60	1.48	1.39	1.75	1.17	1.30	1.30	1.12

Notes

- A. Performance and quality attributes and conditions not expressly stated in this specification document are intended to be excluded and do not form a part of this specification document.
- B. Electrical specifications and performance data contained in this specification document are based on Mini-Circuit's applicable established test performance criteria and measurement instructions.
- C. The parts covered by this specification document are subject to Mini-Circuits standard limited warranty and terms and conditions (collectively, "Standard Terms"). Purchasers of this part are entitled to the rights and benefits contained therein. For a full statement of the Standard Terms and the exclusive rights and remedies thereunder, please visit Mini-Circuits' website at www.minicircuits.com/MICLStore/terms.jsp



RF SP4T Switch

ZSWA4-63DR+

Typical Performance Data

TEST CONDITIONS: @Temperature = +25degC

Power In = 0dBm

FREQUENCY (MHz)	INSERTION LOSS (dB)				ISOLATION (dB)				
	COM-RF1	COM-RF2	COM-RF3	COM-RF4	COM-RF1	COM-RF4	RF2-RF3	RF1-RF4	RF2-RF3
					(RF4 Active)	(RF3 Active)	(RF3 Active)	(RF1 Active)	(RF4 Active)
1	0.86	0.88	0.87	0.85	83.77	91.65	97.49	93.73	92.98
10	0.88	0.90	0.89	0.88	87.01	89.25	85.47	87.51	91.41
50	0.90	0.92	0.92	0.90	83.22	86.36	79.16	83.07	78.79
100	0.92	0.95	0.94	0.92	81.77	83.25	75.36	81.46	73.69
200	0.95	0.98	0.97	0.96	81.74	79.33	70.53	77.97	67.94
300	0.99	1.02	1.01	0.99	82.19	75.29	67.46	74.55	64.54
400	1.02	1.05	1.04	1.02	82.19	72.75	65.28	71.76	62.12
500	1.05	1.08	1.07	1.05	84.03	70.71	63.41	69.95	60.24
700	1.10	1.13	1.13	1.11	81.24	66.95	60.43	67.26	57.50
1000	1.19	1.22	1.22	1.19	73.13	62.57	57.04	64.80	54.66
1100	1.21	1.24	1.24	1.21	71.40	61.28	56.08	64.29	53.92
1200	1.24	1.27	1.27	1.24	69.80	60.06	55.21	63.78	53.28
1300	1.26	1.29	1.30	1.26	68.28	58.88	54.40	63.43	52.72
1400	1.29	1.32	1.32	1.29	67.25	57.78	53.65	63.17	52.19
1500	1.31	1.35	1.35	1.31	65.89	56.77	52.91	62.83	51.69
1600	1.33	1.37	1.37	1.33	64.89	55.77	52.23	62.87	51.27
1700	1.35	1.39	1.39	1.35	63.85	54.82	51.58	62.91	50.86
1800	1.37	1.41	1.41	1.37	62.93	53.96	50.96	63.03	50.48
1900	1.39	1.43	1.43	1.39	61.74	53.06	50.37	63.27	50.21
2000	1.41	1.45	1.45	1.41	60.63	52.24	49.79	63.64	49.91
2100	1.43	1.47	1.47	1.43	59.45	51.45	49.23	64.00	49.67
2200	1.46	1.49	1.49	1.45	58.20	50.68	48.72	64.84	49.40
2400	1.49	1.52	1.53	1.48	55.80	49.39	47.75	66.69	48.99
2500	1.50	1.54	1.55	1.50	54.67	48.78	47.27	67.24	48.81
2600	1.52	1.55	1.56	1.51	53.56	48.20	46.82	67.06	48.63
2700	1.53	1.56	1.57	1.52	52.65	47.62	46.36	66.13	48.47
2800	1.54	1.58	1.58	1.53	51.74	47.08	45.92	64.60	48.34
3000	1.55	1.59	1.59	1.54	50.19	46.02	45.06	60.44	48.06
3200	1.57	1.60	1.60	1.56	48.82	44.96	44.20	56.92	47.82
3400	1.58	1.62	1.61	1.57	47.53	43.91	43.28	53.83	47.59
3600	1.60	1.63	1.63	1.59	46.28	42.87	42.36	51.17	47.31
3800	1.62	1.66	1.65	1.61	45.00	41.86	41.43	48.91	47.03
4000	1.66	1.69	1.69	1.64	43.72	40.93	40.46	46.80	46.75
4200	1.70	1.74	1.74	1.69	42.50	40.01	39.51	44.90	46.52
4400	1.76	1.78	1.79	1.75	41.33	39.12	38.57	43.06	46.35
4600	1.83	1.84	1.85	1.83	39.92	38.30	37.66	41.17	46.35
4800	1.91	1.90	1.93	1.92	38.85	37.43	36.46	39.32	46.29
5000	1.94	1.95	1.99	1.99	38.12	36.63	35.27	38.59	47.47
5200	1.98	2.00	2.05	2.07	37.64	35.58	34.31	37.93	46.29
5300	2.01	2.03	2.09	2.11	37.21	34.92	33.79	37.34	45.48
5400	2.04	2.07	2.13	2.16	36.74	34.25	33.29	36.70	44.84
5500	2.07	2.10	2.17	2.21	36.20	33.59	32.71	35.96	44.27
5600	2.11	2.14	2.21	2.26	35.67	32.96	32.10	35.20	43.75
5700	2.15	2.18	2.26	2.32	35.12	32.35	31.45	34.42	43.24
5800	2.19	2.22	2.31	2.37	34.57	31.78	30.82	33.64	42.69
5900	2.24	2.27	2.36	2.43	34.04	31.24	30.16	32.85	42.10
6000	2.29	2.33	2.42	2.50	33.52	30.76	29.57	32.07	41.50
6100	2.36	2.39	2.49	2.57	33.01	30.32	29.03	31.29	40.96
6200	2.44	2.47	2.57	2.66	32.52	29.88	28.61	30.56	40.60
6300	2.53	2.56	2.66	2.76	32.06	29.48	28.17	29.82	40.41
6400	2.62	2.64	2.74	2.86	31.62	29.08	27.70	29.06	40.29
6600	2.84	2.82	2.94	3.12	30.89	28.37	26.70	27.58	40.04
6800	3.12	3.04	3.19	3.43	30.26	27.70	25.74	26.16	39.56
7000	3.46	3.32	3.51	3.82	29.90	27.02	24.86	24.79	39.16

Notes

- A. Performance and quality attributes and conditions not expressly stated in this specification document are intended to be excluded and do not form a part of this specification document.
- B. Electrical specifications and performance data contained in this specification document are based on Mini-Circuits' applicable established test performance criteria and measurement instructions.
- C. The parts covered by this specification document are subject to Mini-Circuits standard limited warranty and terms and conditions (collectively, "Standard Terms"). Purchasers of this part are entitled to the rights and benefits contained therein. For a full statement of the Standard Terms and the exclusive rights and remedies thereunder, please visit Mini-Circuits' website at www.minicircuits.com/MICStore/terms.jsp



RF SP4T Switch

ZSWA4-63DR+

Typical Performance Data

TEST CONDITIONS: @Temperature = +25degC

Power In = 0dBm

FREQUENCY (MHz)	VSWR								Off (terminated) State VSWR			
	(:1)								(:1)			
	COM RF1 Active	COM RF2 Active	COM RF3 Active	COM RF4 Active	RF1 RF1 Active	RF2 RF2 Active	RF3 RF3 Active	RF4 RF4 Active	RF1	RF2	RF3	RF4
1	1.21	1.22	1.23	1.20	1.22	1.22	1.22	1.21	1.11	1.12	1.12	1.11
10	1.19	1.20	1.21	1.18	1.20	1.20	1.20	1.20	1.11	1.12	1.12	1.11
50	1.19	1.20	1.22	1.18	1.20	1.21	1.20	1.20	1.11	1.12	1.12	1.11
100	1.20	1.20	1.22	1.18	1.21	1.21	1.21	1.20	1.11	1.12	1.12	1.10
200	1.20	1.21	1.22	1.20	1.20	1.21	1.21	1.20	1.11	1.11	1.11	1.10
300	1.21	1.21	1.24	1.20	1.21	1.21	1.21	1.20	1.11	1.11	1.11	1.10
400	1.21	1.22	1.25	1.19	1.20	1.21	1.21	1.20	1.10	1.11	1.11	1.10
500	1.22	1.22	1.25	1.20	1.20	1.21	1.21	1.20	1.10	1.11	1.11	1.10
700	1.23	1.23	1.25	1.22	1.19	1.20	1.20	1.19	1.10	1.12	1.12	1.11
1000	1.25	1.24	1.24	1.23	1.17	1.18	1.18	1.17	1.10	1.12	1.12	1.11
1100	1.25	1.24	1.24	1.23	1.17	1.18	1.18	1.17	1.10	1.12	1.12	1.11
1200	1.25	1.24	1.24	1.23	1.16	1.17	1.17	1.16	1.10	1.12	1.11	1.11
1300	1.26	1.25	1.24	1.23	1.16	1.16	1.16	1.15	1.10	1.12	1.11	1.11
1400	1.26	1.25	1.25	1.23	1.15	1.16	1.15	1.14	1.10	1.12	1.12	1.12
1500	1.26	1.25	1.26	1.23	1.14	1.15	1.14	1.14	1.10	1.12	1.12	1.12
1600	1.26	1.25	1.26	1.23	1.14	1.14	1.13	1.13	1.11	1.12	1.12	1.13
1700	1.26	1.25	1.27	1.23	1.13	1.14	1.13	1.12	1.11	1.12	1.12	1.13
1800	1.26	1.26	1.27	1.23	1.13	1.14	1.12	1.12	1.12	1.12	1.13	1.14
1900	1.26	1.26	1.27	1.23	1.12	1.14	1.12	1.11	1.12	1.13	1.14	1.15
2000	1.26	1.26	1.26	1.24	1.13	1.14	1.13	1.11	1.13	1.13	1.15	1.17
2100	1.26	1.27	1.28	1.25	1.13	1.15	1.14	1.12	1.14	1.14	1.16	1.18
2200	1.26	1.27	1.27	1.25	1.14	1.15	1.15	1.12	1.16	1.15	1.18	1.20
2400	1.26	1.28	1.27	1.26	1.16	1.17	1.17	1.14	1.18	1.16	1.21	1.24
2500	1.26	1.29	1.26	1.27	1.18	1.18	1.18	1.15	1.20	1.18	1.23	1.26
2600	1.26	1.29	1.27	1.28	1.19	1.19	1.19	1.17	1.21	1.19	1.24	1.28
2700	1.26	1.29	1.28	1.28	1.20	1.20	1.19	1.18	1.22	1.20	1.26	1.30
2800	1.26	1.29	1.27	1.27	1.21	1.20	1.19	1.19	1.24	1.21	1.27	1.32
3000	1.26	1.28	1.27	1.26	1.23	1.20	1.19	1.20	1.26	1.23	1.30	1.36
3200	1.25	1.25	1.26	1.23	1.23	1.19	1.17	1.20	1.28	1.24	1.31	1.39
3400	1.23	1.21	1.23	1.20	1.21	1.17	1.14	1.18	1.29	1.25	1.32	1.41
3600	1.19	1.15	1.17	1.16	1.19	1.15	1.11	1.14	1.30	1.26	1.32	1.42
3800	1.15	1.10	1.12	1.14	1.14	1.13	1.10	1.10	1.29	1.25	1.30	1.42
4000	1.13	1.05	1.06	1.10	1.10	1.14	1.12	1.05	1.28	1.23	1.27	1.41
4200	1.13	1.04	1.02	1.06	1.05	1.17	1.15	1.02	1.26	1.21	1.24	1.38
4400	1.13	1.05	1.05	1.04	1.05	1.20	1.19	1.07	1.23	1.20	1.20	1.35
4600	1.13	1.06	1.10	1.06	1.08	1.24	1.21	1.11	1.21	1.18	1.17	1.30
4800	1.13	1.07	1.14	1.11	1.12	1.27	1.24	1.15	1.18	1.16	1.14	1.26
5000	1.14	1.09	1.13	1.15	1.15	1.31	1.27	1.18	1.17	1.16	1.13	1.23
5200	1.15	1.11	1.15	1.22	1.19	1.33	1.28	1.21	1.17	1.17	1.14	1.19
5300	1.16	1.13	1.16	1.25	1.21	1.33	1.29	1.23	1.17	1.17	1.14	1.18
5400	1.17	1.15	1.14	1.28	1.23	1.35	1.30	1.25	1.18	1.17	1.15	1.17
5500	1.18	1.17	1.15	1.32	1.24	1.34	1.30	1.26	1.18	1.18	1.17	1.16
5600	1.20	1.19	1.16	1.33	1.26	1.34	1.30	1.27	1.19	1.19	1.18	1.16
5700	1.23	1.22	1.17	1.36	1.28	1.34	1.29	1.29	1.20	1.19	1.19	1.16
5800	1.25	1.24	1.23	1.37	1.28	1.33	1.28	1.28	1.20	1.20	1.20	1.16
5900	1.31	1.28	1.29	1.39	1.30	1.32	1.28	1.31	1.21	1.20	1.21	1.17
6000	1.35	1.33	1.34	1.38	1.32	1.31	1.27	1.32	1.21	1.20	1.21	1.17
6100	1.41	1.38	1.37	1.41	1.34	1.31	1.27	1.34	1.21	1.20	1.22	1.17
6200	1.46	1.43	1.43	1.43	1.36	1.31	1.28	1.36	1.21	1.21	1.22	1.18
6300	1.53	1.50	1.50	1.46	1.39	1.31	1.30	1.38	1.20	1.21	1.22	1.18
6400	1.60	1.56	1.61	1.50	1.42	1.32	1.33	1.41	1.20	1.22	1.23	1.18
6600	1.76	1.69	1.81	1.58	1.50	1.37	1.39	1.50	1.18	1.21	1.23	1.18
6800	1.96	1.85	1.94	1.75	1.59	1.43	1.47	1.60	1.15	1.21	1.23	1.16
7000	2.21	2.04	2.17	2.01	1.68	1.51	1.56	1.73	1.13	1.20	1.22	1.14

Notes

- A. Performance and quality attributes and conditions not expressly stated in this specification document are intended to be excluded and do not form a part of this specification document.
- B. Electrical specifications and performance data contained in this specification document are based on Mini-Circuits' applicable established test performance criteria and measurement instructions.
- C. The parts covered by this specification document are subject to Mini-Circuits standard limited warranty and terms and conditions (collectively, "Standard Terms"). Purchasers of this part are entitled to the rights and benefits contained therein. For a full statement of the Standard Terms and the exclusive rights and remedies thereunder, please visit Mini-Circuits' website at www.minicircuits.com/MCLStore/terms.jsp



RF SP4T Switch

ZSWA4-63DR+

Typical Performance Data

TEST CONDITIONS: @Temperature =+85degC

Power In = 0dBm

FREQUENCY (MHz)	INSERTION LOSS (dB)				ISOLATION (dB)				
	COM-RF1	COM-RF2	COM-RF3	COM-RF4	COM-RF1	COM-RF4	RF2-RF3	RF1-RF4	RF2-RF3
					(RF4 Active)	(RF3 Active)	(RF3 Active)	(RF1 Active)	(RF4 Active)
1	0.93	0.96	0.95	0.94	86.54	91.65	89.77	95.65	92.14
10	0.95	0.98	0.97	0.96	87.37	89.25	84.84	88.25	90.93
50	0.97	1.00	0.99	0.98	82.00	86.36	80.19	83.55	79.23
100	0.99	1.02	1.01	1.00	81.44	83.25	75.78	82.56	74.01
200	1.02	1.05	1.04	1.03	81.25	79.33	71.04	78.38	68.36
300	1.06	1.10	1.09	1.08	80.66	75.29	67.80	74.30	64.92
400	1.11	1.14	1.13	1.12	81.40	72.75	65.52	71.99	62.72
500	1.14	1.17	1.17	1.15	81.04	70.71	63.72	70.25	60.76
700	1.20	1.24	1.23	1.21	79.65	66.95	60.69	67.44	58.00
1000	1.29	1.32	1.32	1.30	73.31	62.57	57.28	65.12	55.21
1100	1.32	1.35	1.35	1.33	71.56	61.28	56.35	64.51	54.46
1200	1.34	1.37	1.37	1.35	69.92	60.06	55.50	64.03	53.79
1300	1.37	1.40	1.40	1.37	68.51	58.88	54.72	63.60	53.28
1400	1.39	1.42	1.42	1.40	67.31	57.78	53.90	63.33	52.71
1500	1.41	1.45	1.45	1.42	65.82	56.77	53.17	63.14	52.23
1600	1.44	1.47	1.47	1.44	65.06	55.77	52.42	63.08	51.79
1700	1.46	1.49	1.49	1.46	63.94	54.82	51.90	63.08	51.44
1800	1.48	1.52	1.52	1.49	62.83	53.96	51.26	63.08	51.11
1900	1.50	1.54	1.54	1.51	61.78	53.06	50.67	63.14	50.81
2000	1.53	1.56	1.56	1.53	60.48	52.24	50.07	63.31	50.51
2100	1.55	1.59	1.58	1.56	59.20	51.45	49.52	63.53	50.27
2200	1.58	1.61	1.61	1.58	57.94	50.68	49.04	63.97	50.05
2400	1.61	1.65	1.65	1.61	55.48	49.39	47.99	64.51	49.64
2500	1.63	1.67	1.67	1.63	54.32	48.78	47.55	64.54	49.47
2600	1.64	1.68	1.68	1.64	53.27	48.20	47.08	64.31	49.32
2700	1.66	1.69	1.69	1.65	52.32	47.62	46.67	63.65	49.17
2800	1.67	1.71	1.70	1.66	51.41	47.08	46.24	62.72	49.06
3000	1.68	1.72	1.72	1.68	49.83	46.02	45.37	59.97	48.79
3200	1.70	1.74	1.73	1.70	48.40	44.96	44.49	57.06	48.57
3400	1.72	1.76	1.74	1.72	47.02	43.91	43.57	54.30	48.35
3600	1.74	1.77	1.76	1.73	45.71	42.87	42.56	51.71	48.10
3800	1.77	1.80	1.79	1.76	44.37	41.86	41.57	49.42	47.89
4000	1.81	1.84	1.83	1.79	43.09	40.93	40.56	47.26	47.63
4200	1.85	1.88	1.88	1.85	41.89	40.01	39.50	45.21	47.40
4400	1.91	1.93	1.94	1.92	40.64	39.12	38.37	43.18	47.28
4600	1.97	1.98	2.00	1.99	39.16	38.30	37.12	41.15	47.80
4800	2.04	2.04	2.07	2.09	37.84	37.43	35.59	39.88	49.34
5000	2.08	2.10	2.14	2.15	37.72	36.63	34.82	38.67	48.18
5200	2.12	2.16	2.20	2.23	37.19	35.58	33.98	38.01	45.96
5300	2.16	2.20	2.24	2.28	36.73	34.92	33.56	37.62	45.29
5400	2.21	2.24	2.29	2.34	36.31	34.25	33.10	37.03	44.80
5500	2.25	2.28	2.34	2.40	35.62	33.59	32.64	36.33	44.33
5600	2.30	2.33	2.39	2.46	35.11	32.96	32.15	35.65	43.90
5700	2.34	2.37	2.44	2.53	34.53	32.35	31.59	34.83	43.46
5800	2.40	2.42	2.49	2.59	33.97	31.78	31.01	34.01	42.97
5900	2.45	2.47	2.55	2.65	33.47	31.24	30.33	33.16	42.46
6000	2.52	2.53	2.61	2.72	32.90	30.76	29.71	32.39	41.87
6100	2.59	2.60	2.68	2.81	32.33	30.32	29.01	31.59	41.14
6200	2.67	2.68	2.77	2.90	31.77	29.88	28.31	30.77	40.19
6300	2.75	2.77	2.86	3.00	31.22	29.48	27.63	30.02	39.01
6400	2.85	2.86	2.96	3.10	30.73	29.08	27.08	29.24	37.96
6600	3.08	3.05	3.16	3.36	29.87	28.37	26.18	27.83	37.73
6800	3.37	3.28	3.42	3.68	29.01	27.70	25.37	26.65	37.93
7000	3.73	3.58	3.76	4.11	28.28	27.02	24.53	25.48	37.78

Notes

- A. Performance and quality attributes and conditions not expressly stated in this specification document are intended to be excluded and do not form a part of this specification document.
- B. Electrical specifications and performance data contained in this specification document are based on Mini-Circuits' applicable established test performance criteria and measurement instructions.
- C. The parts covered by this specification document are subject to Mini-Circuits standard limited warranty and terms and conditions (collectively, "Standard Terms"). Purchasers of this part are entitled to the rights and benefits contained therein. For a full statement of the Standard Terms and the exclusive rights and remedies thereunder, please visit Mini-Circuits' website at www.minicircuits.com/MICLStore/terms.jsp



RF SP4T Switch

ZSWA4-63DR+

Typical Performance Data

TEST CONDITIONS: @Temperature =+85degC

Power In = 0dBm

FREQUENCY (MHz)	VSWR								Off (terminated) State VSWR			
	(:1)								(:1)			
	COM RF1 Active	COM RF2 Active	COM RF3 Active	COM RF4 Active	RF1 RF1 Active	RF2 RF2 Active	RF3 RF3 Active	RF4 RF4 Active	RF1	RF2	RF3	RF4
1	1.23	1.23	1.20	1.21	1.23	1.24	1.17	1.23	1.09	1.09	1.09	1.07
10	1.21	1.21	1.18	1.20	1.22	1.22	1.15	1.21	1.09	1.09	1.09	1.07
50	1.21	1.22	1.18	1.20	1.22	1.22	1.15	1.22	1.09	1.09	1.09	1.07
100	1.21	1.22	1.18	1.20	1.22	1.22	1.15	1.21	1.09	1.09	1.10	1.08
200	1.22	1.22	1.20	1.21	1.22	1.22	1.15	1.21	1.10	1.09	1.09	1.08
300	1.24	1.24	1.20	1.21	1.21	1.22	1.16	1.22	1.09	1.09	1.08	1.06
400	1.25	1.25	1.19	1.21	1.21	1.22	1.16	1.21	1.09	1.08	1.08	1.06
500	1.25	1.25	1.20	1.21	1.21	1.22	1.15	1.21	1.09	1.08	1.08	1.07
700	1.25	1.25	1.22	1.22	1.21	1.22	1.15	1.21	1.09	1.08	1.07	1.07
1000	1.25	1.24	1.23	1.23	1.20	1.20	1.12	1.20	1.09	1.08	1.08	1.09
1100	1.25	1.24	1.23	1.24	1.19	1.20	1.12	1.20	1.09	1.09	1.08	1.09
1200	1.25	1.24	1.23	1.24	1.18	1.19	1.11	1.20	1.09	1.09	1.08	1.09
1300	1.25	1.24	1.23	1.24	1.17	1.18	1.10	1.20	1.09	1.09	1.08	1.10
1400	1.25	1.25	1.23	1.25	1.16	1.17	1.09	1.18	1.09	1.09	1.08	1.11
1500	1.26	1.26	1.23	1.25	1.16	1.16	1.08	1.17	1.09	1.09	1.09	1.11
1600	1.26	1.26	1.23	1.25	1.15	1.15	1.07	1.16	1.09	1.09	1.10	1.12
1700	1.26	1.27	1.23	1.25	1.14	1.14	1.06	1.15	1.08	1.09	1.10	1.12
1800	1.27	1.27	1.23	1.26	1.13	1.13	1.06	1.14	1.08	1.09	1.11	1.13
1900	1.26	1.27	1.23	1.26	1.13	1.14	1.06	1.14	1.08	1.09	1.12	1.14
2000	1.26	1.26	1.24	1.27	1.13	1.14	1.07	1.14	1.08	1.09	1.13	1.15
2100	1.26	1.28	1.25	1.27	1.14	1.15	1.07	1.14	1.09	1.10	1.14	1.16
2200	1.25	1.27	1.25	1.28	1.14	1.15	1.08	1.14	1.09	1.10	1.15	1.17
2400	1.25	1.27	1.26	1.30	1.15	1.16	1.09	1.15	1.12	1.12	1.18	1.20
2500	1.25	1.26	1.27	1.30	1.16	1.17	1.10	1.15	1.14	1.14	1.19	1.21
2600	1.25	1.27	1.28	1.31	1.16	1.17	1.11	1.16	1.16	1.15	1.20	1.23
2700	1.26	1.28	1.28	1.31	1.17	1.18	1.11	1.16	1.17	1.16	1.22	1.25
2800	1.25	1.27	1.27	1.30	1.17	1.17	1.11	1.16	1.19	1.17	1.23	1.26
3000	1.26	1.27	1.26	1.29	1.18	1.17	1.11	1.17	1.23	1.19	1.24	1.28
3200	1.25	1.26	1.23	1.26	1.19	1.17	1.10	1.18	1.26	1.20	1.25	1.30
3400	1.23	1.23	1.20	1.21	1.19	1.17	1.08	1.18	1.29	1.21	1.24	1.31
3600	1.20	1.17	1.16	1.15	1.19	1.15	1.05	1.16	1.31	1.22	1.23	1.31
3800	1.17	1.12	1.14	1.09	1.17	1.15	1.03	1.13	1.31	1.21	1.21	1.31
4000	1.12	1.06	1.10	1.06	1.12	1.15	1.04	1.09	1.31	1.20	1.18	1.30
4200	1.09	1.02	1.06	1.07	1.10	1.18	1.08	1.09	1.30	1.18	1.15	1.29
4400	1.10	1.05	1.04	1.09	1.09	1.21	1.12	1.12	1.29	1.16	1.12	1.28
4600	1.13	1.10	1.06	1.09	1.10	1.24	1.16	1.20	1.26	1.13	1.09	1.26
4800	1.18	1.14	1.11	1.09	1.13	1.28	1.20	1.28	1.23	1.11	1.07	1.25
5000	1.21	1.13	1.15	1.08	1.16	1.29	1.22	1.33	1.20	1.08	1.07	1.23
5200	1.23	1.15	1.22	1.09	1.20	1.30	1.25	1.40	1.17	1.07	1.08	1.22
5300	1.24	1.16	1.25	1.10	1.21	1.31	1.24	1.41	1.16	1.08	1.09	1.21
5400	1.22	1.14	1.28	1.11	1.22	1.32	1.23	1.41	1.15	1.08	1.11	1.21
5500	1.19	1.15	1.32	1.14	1.23	1.32	1.21	1.41	1.13	1.08	1.12	1.20
5600	1.20	1.16	1.33	1.16	1.24	1.32	1.19	1.40	1.12	1.10	1.13	1.20
5700	1.18	1.17	1.36	1.19	1.26	1.33	1.17	1.38	1.11	1.11	1.15	1.19
5800	1.21	1.23	1.37	1.22	1.30	1.35	1.16	1.40	1.11	1.12	1.16	1.19
5900	1.27	1.29	1.39	1.28	1.35	1.36	1.16	1.41	1.10	1.13	1.17	1.19
6000	1.31	1.34	1.38	1.33	1.38	1.36	1.14	1.42	1.10	1.14	1.18	1.18
6100	1.36	1.37	1.41	1.39	1.42	1.36	1.12	1.45	1.10	1.16	1.18	1.18
6200	1.45	1.43	1.43	1.45	1.46	1.35	1.12	1.48	1.09	1.16	1.19	1.17
6300	1.54	1.50	1.46	1.53	1.46	1.35	1.12	1.49	1.09	1.17	1.20	1.16
6400	1.64	1.61	1.50	1.61	1.48	1.36	1.14	1.53	1.09	1.17	1.20	1.15
6600	1.88	1.81	1.58	1.76	1.55	1.41	1.22	1.67	1.08	1.17	1.20	1.12
6800	2.06	1.94	1.75	1.92	1.61	1.45	1.31	1.78	1.07	1.17	1.18	1.07
7000	2.28	2.17	2.01	2.12	1.66	1.56	1.42	1.90	1.08	1.17	1.18	1.04

Notes

- A. Performance and quality attributes and conditions not expressly stated in this specification document are intended to be excluded and do not form a part of this specification document.
- B. Electrical specifications and performance data contained in this specification document are based on Mini-Circuits' applicable established test performance criteria and measurement instructions.
- C. The parts covered by this specification document are subject to Mini-Circuits standard limited warranty and terms and conditions (collectively, "Standard Terms"). Purchasers of this part are entitled to the rights and benefits contained therein. For a full statement of the Standard Terms and the exclusive rights and remedies thereunder, please visit Mini-Circuits' website at www.minicircuits.com/MCStore/terms.jsp



Typical Performance Curves

Insertion Loss
Temperature -40°C

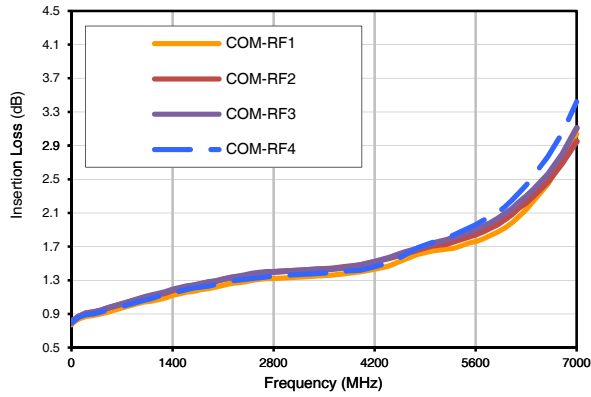

Isolation
Temperature = -40°C

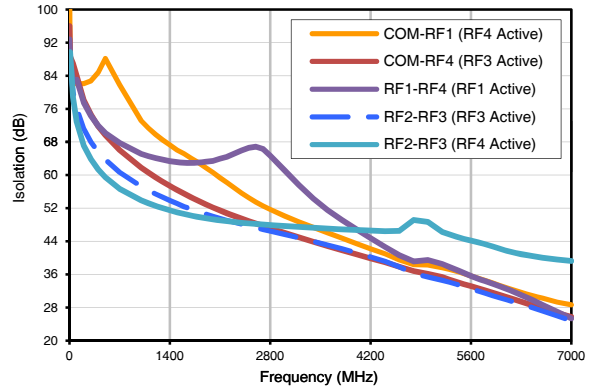

VSWR COM
Temperature = -40°C

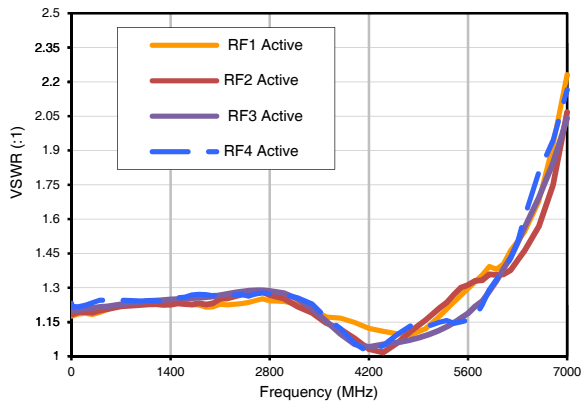

VSWR (RF1, RF2, RF3, RF4)
Temperature = -40°C

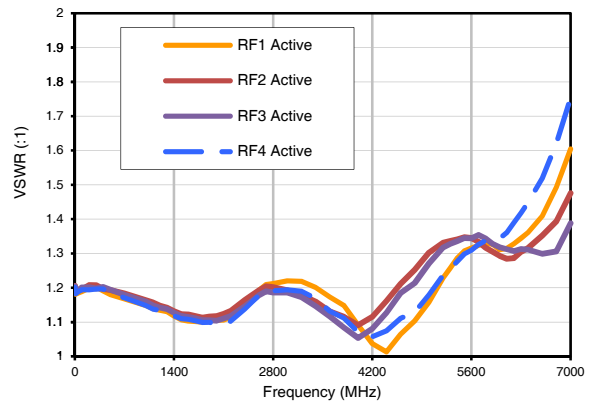

Off (terminated) State VSWR
Temperature = -40°C

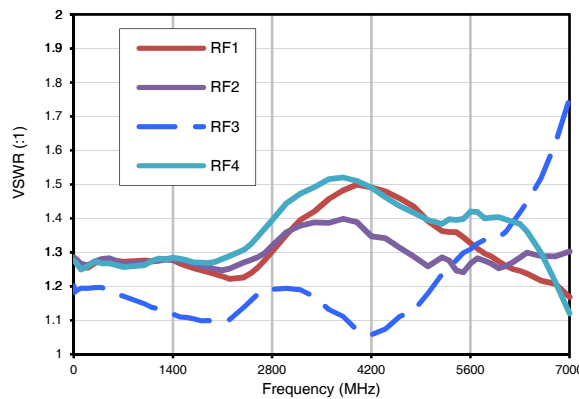

Notes

- A. Performance and quality attributes and conditions not expressly stated in this specification document are intended to be excluded and do not form a part of this specification document.
- B. Electrical specifications and performance data contained in this specification document are based on Mini-Circuits' applicable established test performance criteria and measurement instructions.
- C. The parts covered by this specification document are subject to Mini-Circuits' standard limited warranty and terms and conditions (collectively, "Standard Terms"). Purchasers of this part are entitled to the rights and benefits contained therein. For a full statement of the Standard Terms and the exclusive rights and remedies thereunder, please visit Mini-Circuits' website at: www.minicircuits.com/MCStore/terms.jsp



Typical Performance Curves

Insertion Loss
Temperature +25°C

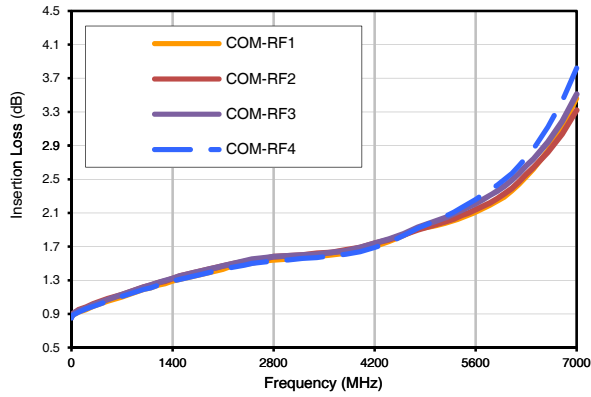

Isolation
Temperature = +25°C

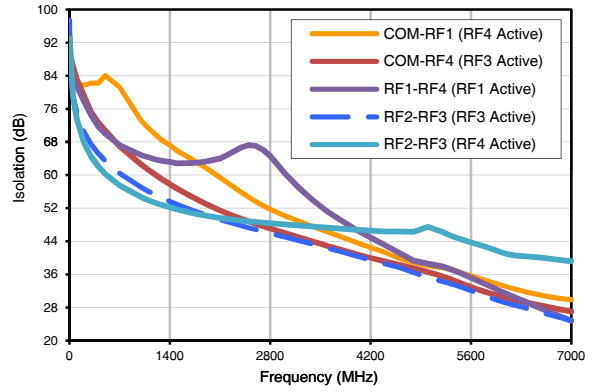

VSWR COM
Temperature = +25°C

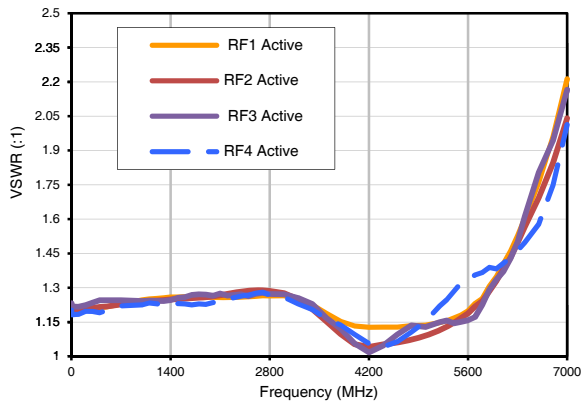

VSWR (RF1, RF2, RF3, RF4)
Temperature = +25°C

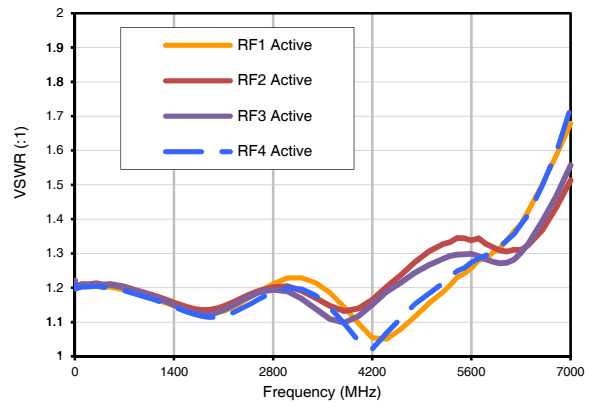

Off (terminated) State VSWR
Temperature = +25°C

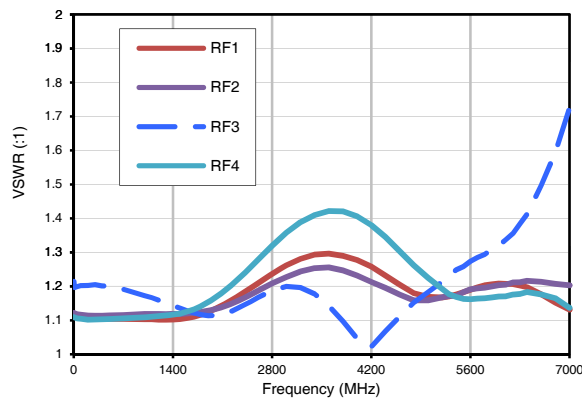

Notes

- A. Performance and quality attributes and conditions not expressly stated in this specification document are intended to be excluded and do not form a part of this specification document.
- B. Electrical specifications and performance data contained in this specification document are based on Mini-Circuits' applicable established test performance criteria and measurement instructions.
- C. The parts covered by this specification document are subject to Mini-Circuits' standard limited warranty and terms and conditions (collectively, "Standard Terms"). Purchasers of this part are entitled to the rights and benefits contained therein. For a full statement of the Standard Terms and the exclusive rights and remedies thereunder, please visit Mini-Circuits' website at: www.minicircuits.com/MCLStore/terms.jsp

Typical Performance Curves

Insertion Loss
Temperature = +85°C

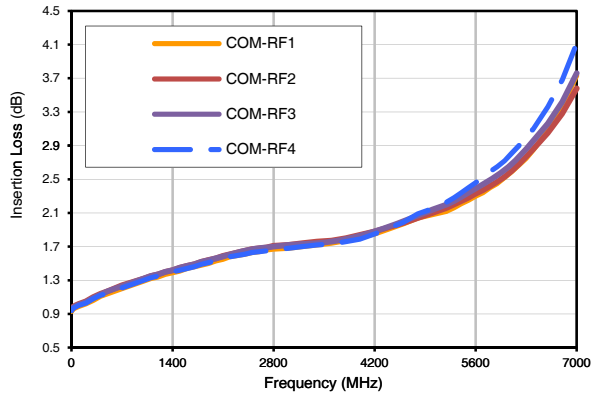

Isolation
Temperature = +85°C

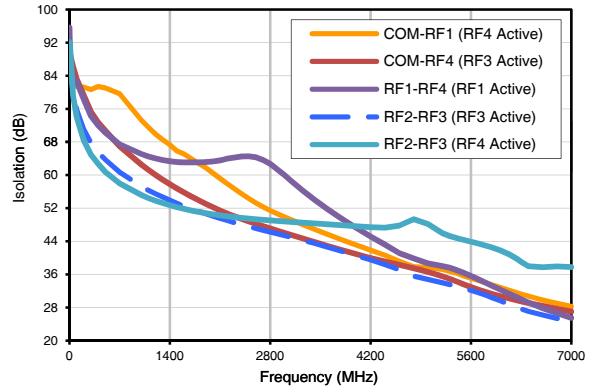

VSWR COM
Temperature = +85°C

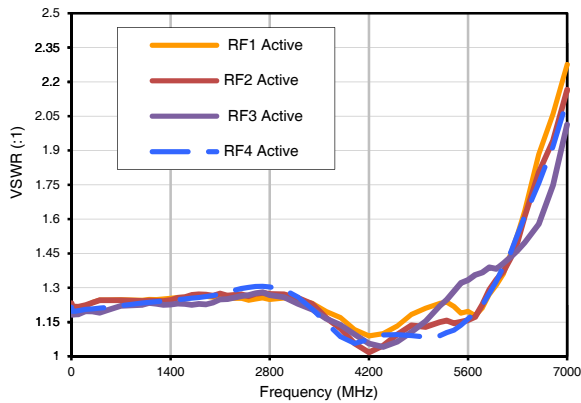

VSWR (RF1, RF2, RF3, RF4)
Temperature = +85°C

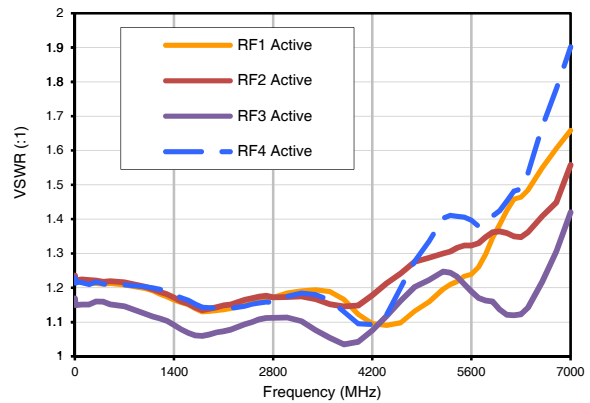

Off (terminated) State VSWR
Temperature = +85°C

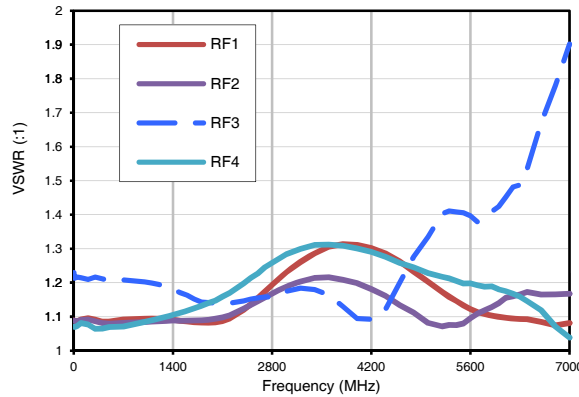

Notes

- A. Performance and quality attributes and conditions not expressly stated in this specification document are intended to be excluded and do not form a part of this specification document.
- B. Electrical specifications and performance data contained in this specification document are based on Mini-Circuits' applicable established test performance criteria and measurement instructions.
- C. The parts covered by this specification document are subject to Mini-Circuits' standard limited warranty and terms and conditions (collectively, "Standard Terms"); Purchasers of this part are entitled to the rights and benefits contained therein. For a full statement of the Standard Terms and the exclusive rights and remedies thereunder, please visit Mini-Circuits' website at www.minicircuits.com/MCStore/terms.jsp

Case Style

QV

Outline Dimensions

QV2425

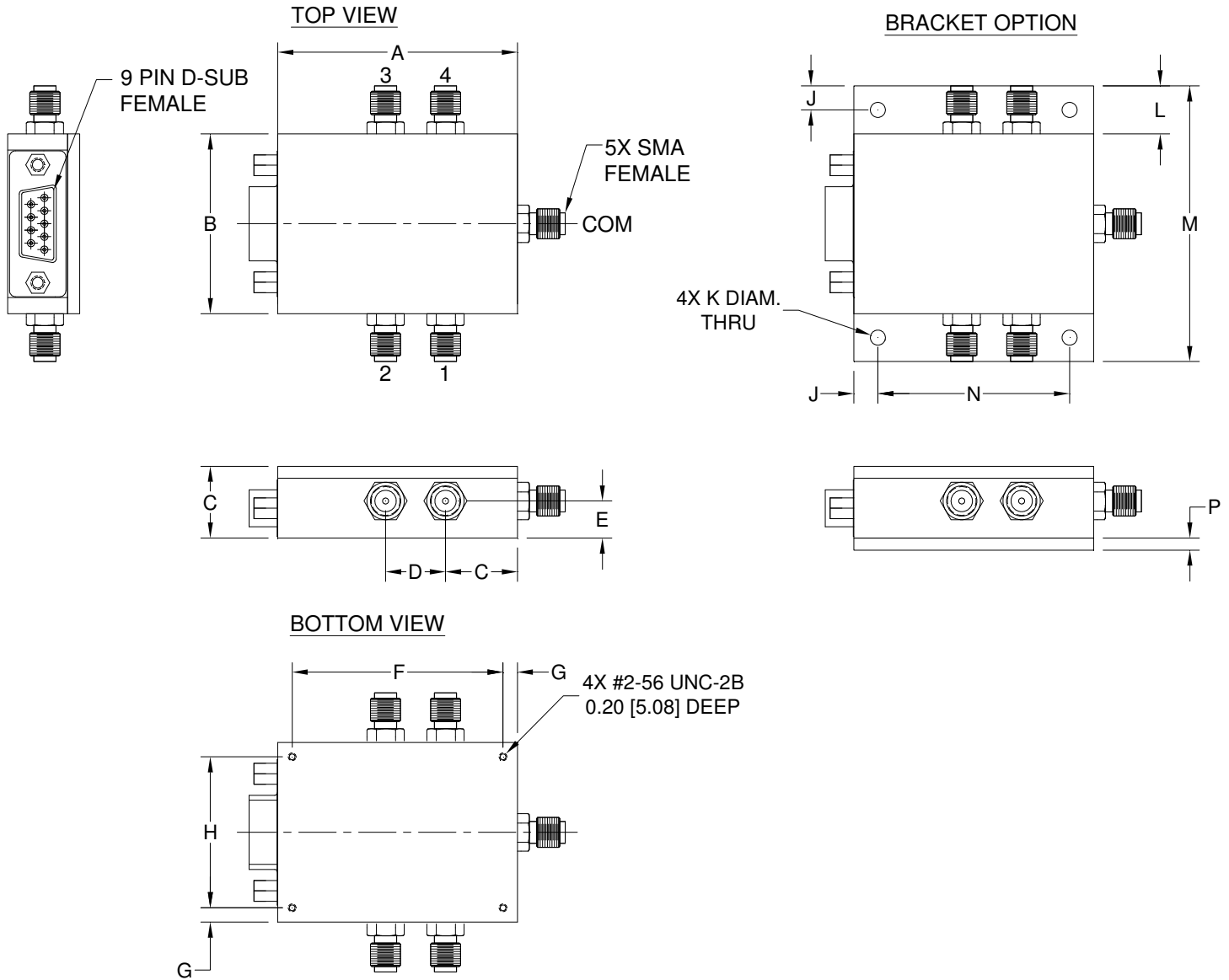

CASE#	A	B	C	D	E	F	G	H	J	K	L	M	N	P	WT. GRAMS
QV2425	2.00 (50.8)	1.50 (38.1)	.60 (15.24)	.500 (12.7)	.31 (7.87)	1.760 (44.7)	.120 (3.05)	1.260 (32.0)	.200 (5.08)	.125 (3.18)	.40 (10.16)	2.30 (58.4)	1.600 (40.64)	.100 (2.54)	70

Dimensions are in inches (mm). Tolerances: 2PL. +/- .03; 3PL. +/- .015

Notes:

1. Case material: Aluminum alloy.
2. Case finish for RoHS Case Styles: Clear chemical conversion coating, non-chrome or trivalent chrome based.

Mini-Circuits[®]

INTERNET <http://www.minicircuits.com>

P.O. Box 350166, Brooklyn, New York 11235-0003 (718) 934-4500 Fax (718) 332-4661

Distribution Centers NORTH AMERICA 800-654-7949 • 417-335-5935 • Fax 417-335-5945 • EUROPE 44-1252-832600 • Fax 44-1252-837010

Mini-Circuits ISO 9001 & ISO 14001 Certified



All Mini-Circuits products are manufactured under exacting quality assurance and control standards, and are capable of meeting published specifications after being subjected to any or all of the following physical and environmental test.

Specification	Test/Inspection Condition	Reference/Spec
Operating Temperature	-40° to 85°C	Individual Model Data Sheet
Storage Temperature	-55° to 100° C Ambient Environment	Individual Model Data Sheet
Barometric Pressure	100,000 Feet	MIL-STD-202, Method 105, Condition D
Humidity	90% RH, 65°C Units may require bake-out after humidity to restore full performance.	MIL-STD-202, Method 103
Thermal Shock	-65° to 125°C, 5 cycles	MIL-STD-202, Method 107, Condition B
Vibration (High Frequency)	20g peak, 10-2000 Hz, 12 times in each of three perpendicular directions (total 36)	MIL-STD-202, Method 204, Condition D
Mechanical Shock	100g, 6ms sawtooth, 3 shocks each direction 3 axes (total 18)	MIL-STD-202, Method 213, Condition I