

Smart Power Sensor

PWR-8GHS-RC

50Ω -30 dBm to +20 dBm, 1 MHz to 8000 MHz

The Big Deal

- **USB or Ethernet** control
- Fast Measurement rate: 30 ms
- Cost effective power measurements
- USB control with full software support



Generic photo used for illustration purposes only

CASE STYLE: JL1941



Software Package

Typical Applications

- Turn any Windows or Linux PC into a Power Meter
- Lab & benchtop testing
- Signal level calibration in production test systems
- Power monitoring in remote installations / base-stations
- Bluetooth / Wi-Fi / 4G / 5G bands covered

Model No.	Description
PWR-8GHS-RC	USB/Ethernet smart Power Sensor
Included Accessories	
PWR-SEN-8GHS-RC	Power Sensor Head
USB-RJ45-CBL-7+	6.6 ft "Y" data cable (USB & RJ45)
NF-SM50+	N-Type (F) to SMA(M) Adapter

RoHS Compliant

See our web site for RoHS Compliance methodologies and qualifications

Product Overview

Mini-Circuits' PWR-8GHS-RC is a compact sensor-head that turns any PC into an average power meter for CW (continuous waveform) signals. The sensor has an 50 dB input dynamic range and wide bandwidth, allowing measurement of RF powers down to -30 dBm over 1 to 8000 MHz.

The USB HID interface is "plug & play" compatible, meaning no driver installation is required, while the additional Ethernet interface allows remote power measurements over a network. Full software support is provided, including our user-friendly GUI application for Windows and a full API with programming instructions for Windows and Linux environments (both 32-bit and 64-bit systems). Download the software package from <http://www.minicircuits.com/softwaredownload/pm.html>

Key Features

Feature	Advantages
USB & Ethernet control	USB HID and Ethernet (HTTP / Telnet) interfaces provide easy compatibility with a wide range of software setups and programming environments
Low power measurement @ 30 ms speed	Accurate and fast power measurements @ 30 ms all the way down to -30 dBm facilitates test applications with high loss and rapid power variations
Automatic measurement compensation	Power measurements are automatically adjusted by the sensor to maintain accuracy with variations in the ambient temperature and across the bandwidth of the sensor
No User calibration required	Accurate power measurements can commence as soon as the sensor is connected since it does not require any zero or reference measurements
Excellent impedance match	Input VSWR of 1.10:1 typ reduces measurement errors due to impedance mismatch

Trademarks: Windows is a registered trademark of Microsoft Corporation in the United States and other countries. Linux is a registered trademark of Linus Torvalds. Mac is a registered trademark of Apple Corporation. Pentium is a registered trademark of Intel Corporation. Neither Mini-Circuits nor the Mini-Circuits PWR-series power sensors are affiliated with or endorsed by the owners of the above referenced trademarks

Mini-Circuits and the Mini-Circuits logo are registered trademarks of Scientific Components Corporation.



Electrical Specifications (CW)¹, -30 dBm to +20 dBm, 1 to 8000 MHz

Parameter	Freq. Range (MHz)	Min.	Typ.	Max.	Units	
Dynamic Range ²	1 - 8000	-30	-	+20	dBm	
VSWR	1 - 8000	-	1.10	1.30	:1	
Uncertainty of Power Measurement @ 25°C	@ -30 to +5 dBm ^{3,4}	1 - 3000	-	± 0.10	± 0.30	dB
		3000 - 8000	-	± 0.15	± 0.40	dB
	@ +5 to +15 dBm	1 - 3000	-	± 0.15	± 0.30	dB
		3000 - 8000	-	± 0.15	± 0.40	dB
	@ +15 to +20 dBm	1 - 3000	-	± 0.15	± 0.40	dB
		3000 - 8000	-	± 0.20	± 0.45	dB
Uncertainty of Power Measurement @ 0°C to 50°C	@ -30 to +5 dBm ^{3,4}	1 - 3000	-	± 0.20	-	dB
		3000 - 8000	-	± 0.20	-	dB
	@ +5 to +15 dBm	1 - 3000	-	± 0.20	-	dB
		3000 - 8000	-	± 0.20	-	dB
	@ +15 to +20 dBm	1 - 3000	-	± 0.20	-	dB
		3000 - 8000	-	± 0.20	-	dB
Linearity @ 25°C	1 - 8000	-	± 3.0	-	%	
Measurement Resolution	1 - 8000	0.01	-	-	dB	
Averaging Range	1 - 8000	1	-	999	-	
Measurement Speed	@ Low Noise Mode	1 - 8000	-	100	-	msec
	@ Faster Mode		-	30	-	
Supply Voltage	via USB port	4.5	5	5.5	V	
Current (via USB port, in USB control)	1 - 8000	-	180	250	mA	
Current (via USB port, in Ethernet control)	1 - 8000	-	190	250	mA	
Ethernet communication	Supports both Telnet and HTTP protocols over TCP/IP with dynamic(DHCP) or static IP					

¹ All specifications apply to continuous wave (CW) signals.

² Maximum continuous safe operational power limit: +23 dBm. Performance is guaranteed up to +20 dBm.

³ When using Faster mode at high frequencies below -20dBm, use of averaging is recommended to prevent noise errors.

⁴ When using Faster mode below -20dBm, uncertainty value may increase by up to 0.2 dB relative to Low noise mode

Absolute Maximum Ratings

Parameter	Ratings
Operating Temperature	0°C to 50°C
Storage Temperature	-30°C to 70°C
V _{USB} Max.	6V
DC Voltage at RF port	15V
CW Power	+27 dBm

Permanent damage may occur if any of these limits are exceeded. Operating in the range between operating power limits and absolute maximum ratings for extended periods of time may result in reduced life and reliability.

Typical Performance Curves

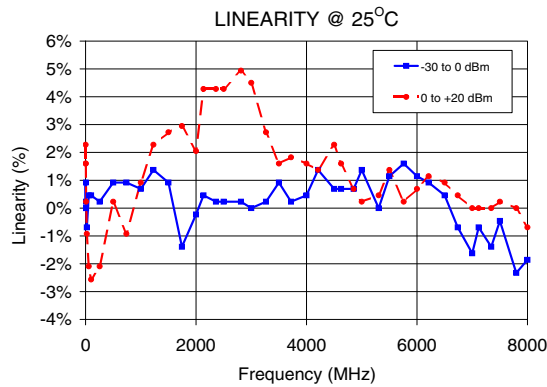
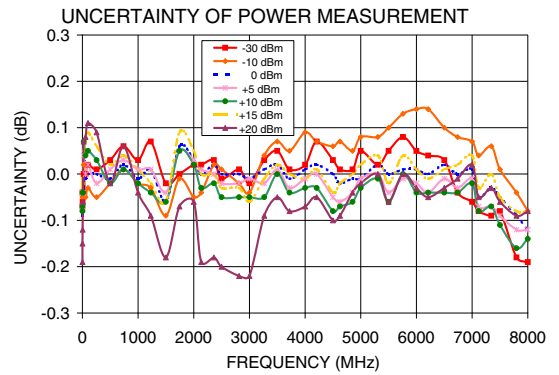
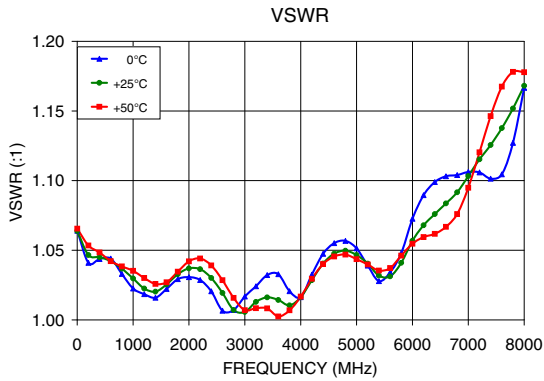

Outline Drawing (JL1941)

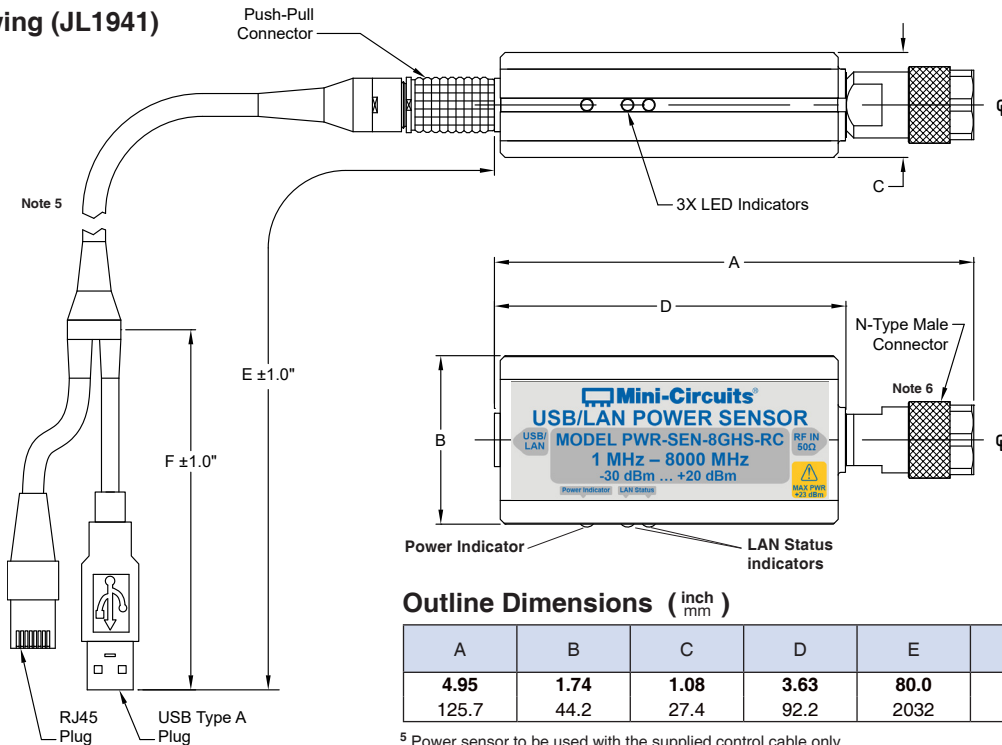

⁵ Power sensor to be used with the supplied control cable only.

⁶ Maximum torque 8 in-lb (90 N-cm).

Connection diagrams

Connection diagram for USB control

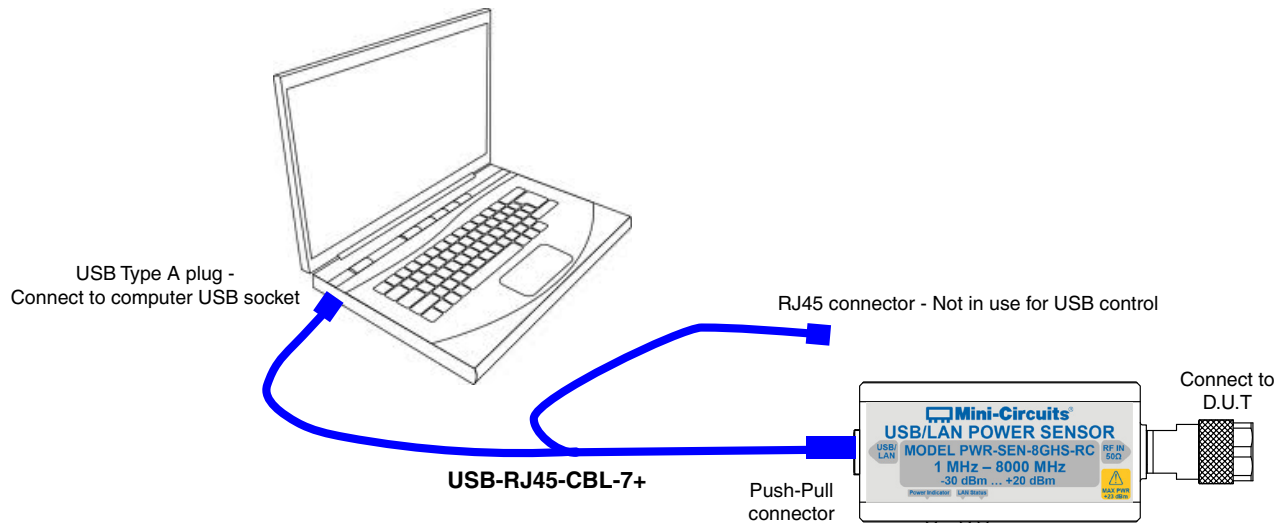

Connection diagram for Ethernet control, using power adapter

Connect USB-AC/DC-5 to mains power

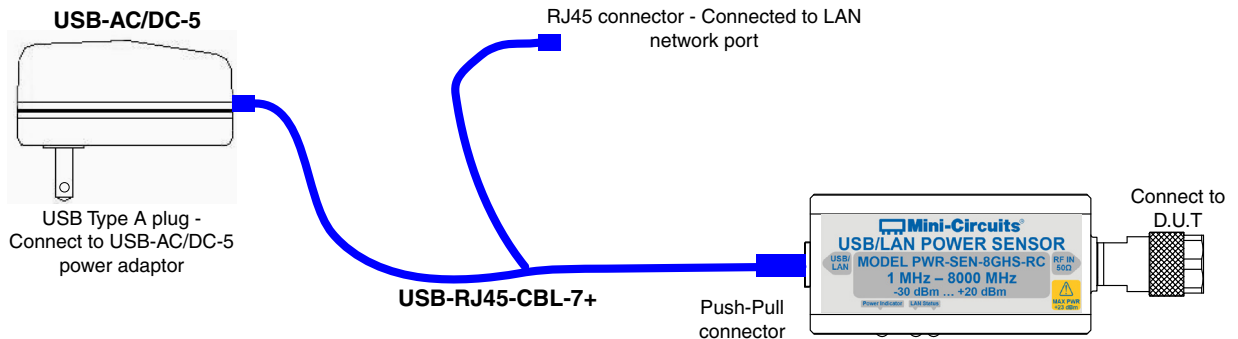

Connection diagram for Ethernet control, using PoE system

Note: Commercially available PoE splitter not supplied by Mini-Circuits

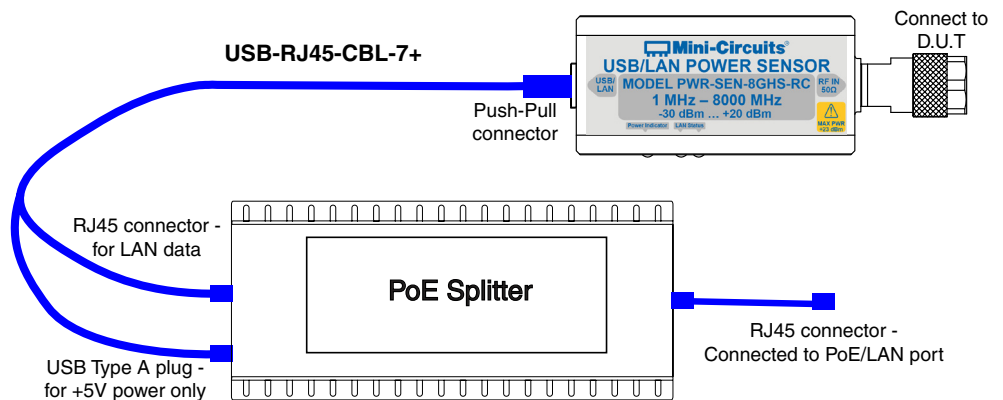

Software & Documentation Download:

- Mini-Circuits' full software and support package including user guide, Windows GUI, DLL files, programming manual and examples can be downloaded free of charge from <http://www.minicircuits.com/softwaredownload/pm.html>.
- Please contact testsolutions@minicircuits.com for support

Minimum System Requirements

Parameter	Requirements	
Interface	USB HID or HTTP Get/Post or Telnet protocols	
System requirements	GUI:	Windows 32 & 64 bit systems from Windows 98 up to Windows 10
	USB API (ActiveX & .Net)	Windows 32 & 64 bit systems with ActiveX or .Net support from Windows 98 up to Windows 10
	USB direct programming support	Linux, Windows systems from Windows 98 up to Windows 10
	Telnet & HTTP	Any Windows, Mac, or Linux computer with a network port and Ethernet-TCP/IP (HTTP or Telnet protocols) support
Hardware	Pentium® II or higher, RAM 256 MB	
Y control cable for USB and Ethernet (supplied)	Power sensor to be used with the supplied control cable only	

Graphical User Interface (GUI) for Windows

Key Features:

- Set compensation frequency and monitor power measurement
- Configure measurement offsets and relative power readings
- Set measurement mode (speed and averaging)
- Control multiple power sensors at once
- Schedule data recording
- Guided measurements for a variety of applications (characterizing a two port device, power monitoring, etc.)

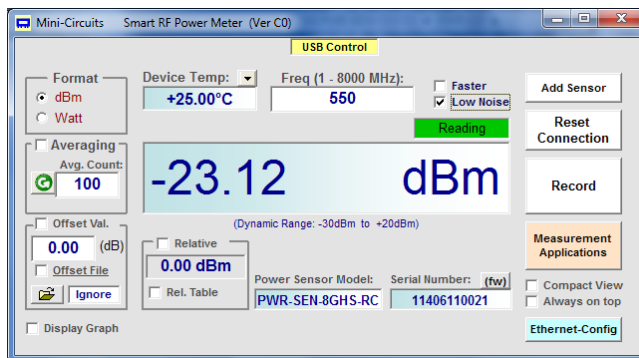

Application Programming Interface (API)

Windows Support:

- API DLL files exposing the full power sensor functionality. See programming manual at https://www.minicircuits.com/softwaredownload/Prog_Manual-4-Power_Meter.pdf for details
 - ActiveX COM DLL file for creation of 32-bit programs
 - .Net library DLL file for creation of 32 / 64-bit programs
- HTTP Get/Post and Telnet protocols use SCPI commands to provide full control.
- Supported by most common programming environments (refer to application note [AN-49-001](#) for summary of tested environments)



Linux Support:

- Full power sensor control in a Linux environment is achieved by way of USB interrupt commands. See programming manual at https://www.minicircuits.com/softwaredownload/Prog_Manual-4-Power_Meter.pdf for details.



Ordering Information

Model	Description
PWR-8GHS-RC	USB/Ethernet <i>Smart Power Sensor</i>

Included Accessories	Part No.	Description
	PWR-SEN-8GHS-RC	Power Sensor Head
	USB-RJ45-CBL-7+	6.6 ft (2 m) "Y" data cable with USB Type-A and RJ45 plug connectors ⁷
	NF-SM50+	N-Type Female to SMA Male Adapter.

⁷ Power sensor to be used with the supplied control cable only.

Optional Accessories	Description
USB-AC/DC-5+	AC/DC 5V _{DC} Power Adapter with US, EU, IL, UK, AUS, and China power plugs ⁸
USB-RJ45-CBL-7+ (spare)	6.6 ft (2 m) "Y" data cable with USB Type-A and RJ45 plug connectors
NF-SM50+(spare)	N-Type Female to SMA Male Adapter.
NF-SF50+	N-Type Female to SMA Female Adapter
NF-BM50+	N-Type Female to BNC Male Adapter.

⁸ Power plugs for other countries are also available, Plugs for other countries are also available, if you need a power plug for a country not listed please contact testsolutions@minicircuits.com.

Calibration	Description
CALSEN-8GHS-RC	Calibration Service Click Here

Additional Notes

- A. Performance and quality attributes and conditions not expressly stated in this specification document are intended to be excluded and do not form a part of this specification document.
- B. Electrical specifications and performance data contained in this specification document are based on Mini-Circuit's applicable established test performance criteria and measurement instructions.
- C. The parts covered by this specification document are subject to Mini-Circuits standard limited warranty and terms and conditions (collectively, "Standard Terms"); Purchasers of this part are entitled to the rights and benefits contained therein. For a full statement of the Standard Terms and the exclusive rights and remedies thereunder, please visit Mini-Circuits' website at www.minicircuits.com/MCLStore/terms.jsp

USB Power Sensor

PWR-8GHS-RC

Typical Performance Data

FREQ. (MHz)	VSWR (:1)		
	0°C	+25°C	+50°C
1	1.06	1.06	1.07
10	1.05	1.05	1.05
20	1.05	1.05	1.05
50	1.05	1.05	1.05
100	1.04	1.05	1.05
200	1.04	1.05	1.05
400	1.04	1.05	1.05
600	1.04	1.04	1.04
800	1.03	1.04	1.04
1000	1.02	1.03	1.04
1200	1.02	1.02	1.03
1400	1.02	1.02	1.03
1600	1.02	1.03	1.03
1800	1.03	1.03	1.03
2000	1.03	1.04	1.04
2200	1.03	1.04	1.04
2400	1.02	1.03	1.04
2600	1.01	1.02	1.03
2800	1.01	1.01	1.02
3000	1.02	1.01	1.01
3200	1.02	1.01	1.01
3400	1.03	1.02	1.01
3600	1.03	1.01	1.00
3800	1.02	1.01	1.01
4000	1.02	1.02	1.02
4200	1.03	1.03	1.03
4400	1.05	1.04	1.04
4600	1.06	1.05	1.05
4800	1.06	1.05	1.05
5000	1.05	1.05	1.04
5200	1.04	1.04	1.04
5400	1.03	1.03	1.04
5600	1.03	1.03	1.04
5800	1.05	1.04	1.05
6000	1.07	1.06	1.05
6200	1.09	1.07	1.06
6400	1.10	1.08	1.06
6600	1.10	1.08	1.07
6800	1.10	1.09	1.08
7000	1.11	1.10	1.09
7500	1.10	1.13	1.16
8000	1.17	1.17	1.18

LINEARITY @ -30 to 0	
FREQ (MHz)	- (%)
0.5	0.23
1.0	0.23
10.0	-0.23
57.0	0.46
100.0	0.23
500.0	1.83
1000.0	1.37
1500.0	0.00
2000.0	-1.16
2500.0	-0.23
3000.0	0.69
4000.0	1.14
5000.0	-0.23
6000.0	0.69
7000.0	0.69
8000.0	-2.09

LINEARITY @ 0 to +20	
FREQ (MHz)	- (%)
0.5	0.69
1.0	0.00
10.0	-1.39
57.0	-3.99
100.0	-4.23
500.0	-1.39
1000.0	-0.93
1500.0	1.37
2000.0	0.00
2500.0	2.73
3000.0	3.39
4000.0	-0.23
5000.0	-2.09
6000.0	-1.86
7000.0	-3.28
8000.0	-5.20

Notes

- A. Performance and quality attributes and conditions not expressly stated in this specification document are intended to be excluded and do not form a part of this specification document.
- B. Electrical specifications and performance data contained in this specification document are based on Mini-Circuits' applicable established test performance criteria and measurement instructions.
- C. The parts covered by this specification document are subject to Mini-Circuits standard limited warranty and terms and conditions (collectively, "Standard Terms"); Purchasers of this part are entitled to the rights and benefits contained therein. For a full statement of the Standard Terms and the exclusive rights and remedies thereunder, please visit Mini-Circuits' website at www.minicircuits.com/MQLStore/terms.jsp



Typical Performance Data

FREQ. (MHz)	UNCERTAINTY OF POWER MEASUREMENT @ 25°C (dBm)						
	-30	-10	0	+5	+10	+15	+20
0	-0.34	-0.36	-0.25	-0.21	-0.20	-0.22	-0.50
1	-0.14	-0.13	-0.12	-0.10	-0.10	-0.10	-0.26
1	-0.07	-0.07	-0.09	-0.07	-0.07	-0.06	-0.19
2	-0.04	-0.06	-0.07	-0.06	-0.07	-0.05	-0.15
5	-0.05	-0.04	-0.05	-0.04	-0.04	-0.02	-0.12
10	-0.05	-0.04	-0.05	-0.04	-0.03	0.00	-0.06
23	0.01	0.02	0.03	0.05	0.06	0.05	0.08
57	0.00	-0.04	0.00	0.01	0.03	0.06	0.08
100	0.01	-0.02	0.00	0.01	0.05	0.09	0.11
255	0.01	-0.05	-0.01	-0.02	0.02	0.05	0.08
500	0.02	-0.03	-0.01	0.01	-0.02	0.02	-0.01
739	0.06	0.02	0.01	0.03	0.00	0.04	0.05
1000	0.02	-0.03	0.00	0.00	-0.03	0.01	-0.03
1229	0.06	-0.02	0.00	0.01	-0.04	-0.02	-0.09
1500	-0.03	-0.09	-0.05	-0.04	-0.07	-0.06	-0.17
1744	0.00	-0.02	0.06	0.05	0.06	0.10	-0.06
2000	0.01	-0.04	0.03	0.03	0.02	0.06	-0.06
2135	0.02	-0.04	0.01	0.01	-0.03	-0.01	-0.19
2361	0.03	0.01	0.02	0.00	-0.02	-0.01	-0.18
2500	-0.01	0.01	-0.01	-0.02	-0.05	-0.03	-0.20
2814	0.00	-0.03	-0.01	-0.02	-0.04	-0.04	-0.22
3000	-0.02	-0.04	-0.01	-0.01	-0.05	-0.05	-0.22
3267	0.04	0.05	0.02	-0.02	-0.04	-0.01	-0.09
3500	0.06	0.07	0.02	0.01	-0.01	0.02	-0.05
3720	0.00	0.05	-0.01	-0.03	-0.04	-0.01	-0.08
4000	0.01	0.09	0.01	-0.01	-0.03	0.00	-0.07
4209	0.06	0.08	0.01	0.00	-0.02	0.02	-0.05
4500	0.03	0.07	0.00	-0.05	-0.07	-0.04	-0.10
4626	0.01	0.06	-0.03	-0.07	-0.08	-0.03	-0.09
4853	0.02	0.05	-0.01	-0.04	-0.06	0.00	-0.04
5000	0.05	0.08	-0.01	-0.01	-0.02	0.02	-0.02
5306	0.03	0.09	0.02	0.00	-0.01	0.04	0.00
5500	0.05	0.10	0.00	-0.05	-0.06	-0.02	-0.06
5759	0.08	0.14	0.01	-0.01	-0.01	0.03	-0.01
6000	0.05	0.14	0.00	-0.01	-0.04	0.01	-0.02
6212	0.04	0.14	0.01	-0.03	-0.04	-0.01	-0.06
6500	0.03	0.10	0.01	-0.02	-0.04	0.01	-0.02
6738	-0.03	0.08	0.00	-0.03	-0.05	0.01	-0.02
7000	-0.06	0.07	0.01	-0.01	-0.02	0.04	0.01
7118	-0.08	0.04	-0.04	-0.08	-0.08	-0.02	-0.05
7344	-0.08	0.05	-0.03	-0.07	-0.07	0.00	-0.03
7500	-0.08	0.02	-0.05	-0.11	-0.12	-0.05	-0.07
7797	-0.18	-0.05	-0.09	-0.12	-0.15	-0.08	-0.10
8000	-0.19	-0.09	-0.12	-0.13	-0.14	-0.08	-0.08
8250	-0.13	0.01	0.01	-0.03	-0.03	0.06	0.07

Notes

- A. Performance and quality attributes and conditions not expressly stated in this specification document are intended to be excluded and do not form a part of this specification document.
- B. Electrical specifications and performance data contained in this specification document are based on Mini-Circuits' applicable established test performance criteria and measurement instructions.
- C. The parts covered by this specification document are subject to Mini-Circuits standard limited warranty and terms and conditions (collectively, "Standard Terms"); Purchasers of this part are entitled to the rights and benefits contained therein. For a full statement of the Standard Terms and the exclusive rights and remedies thereunder, please visit Mini-Circuits' website at www.minicircuits.com/MCLStore/terms.jsp



Typical Performance Curves

VSWR

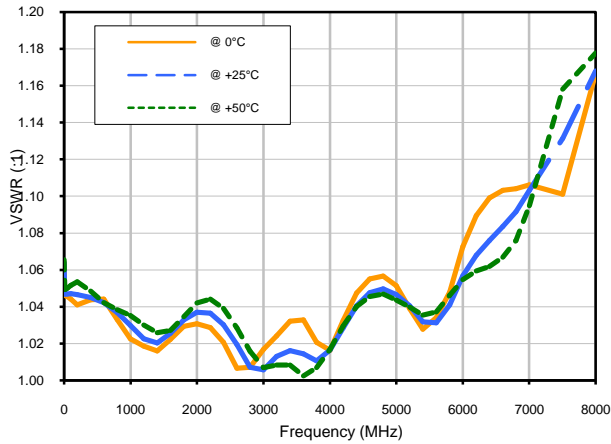

UNCERTAINTY OF POWER MEASUREMENT @ 25°C

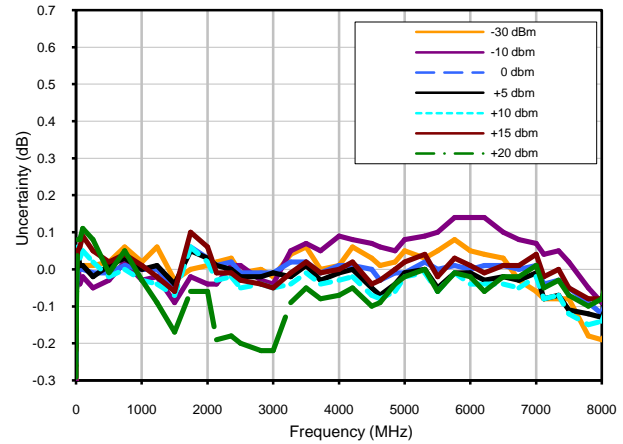

LINEARITY @ 25°C

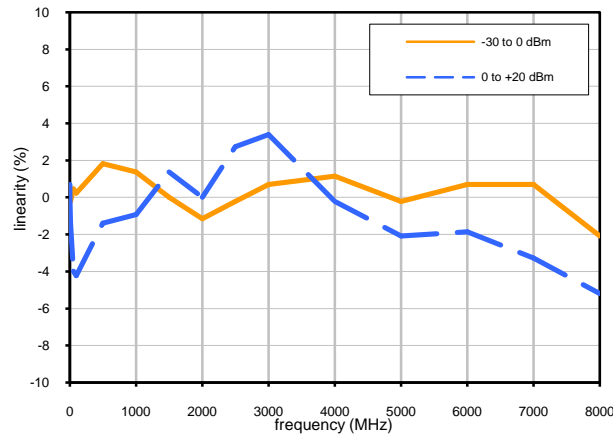

Notes

- A. Performance and quality attributes and conditions not expressly stated in this specification document are intended to be excluded and do not form a part of this specification document.
- B. Electrical specifications and performance data contained in this specification document are based on Mini-Circuits' applicable established test performance criteria and measurement instructions.
- C. The parts covered by this specification document are subject to Mini-Circuits standard limited warranty and terms and conditions (collectively, "Standard Terms"); Purchasers of this part are entitled to the rights and benefits contained therein. For a full statement of the Standard Terms and the exclusive rights and remedies thereunder, please visit Mini-Circuits' website at www.minicircuits.com/MCLStore/terms.jsp



Case Style

JL

Outline Dimensions

JL1941

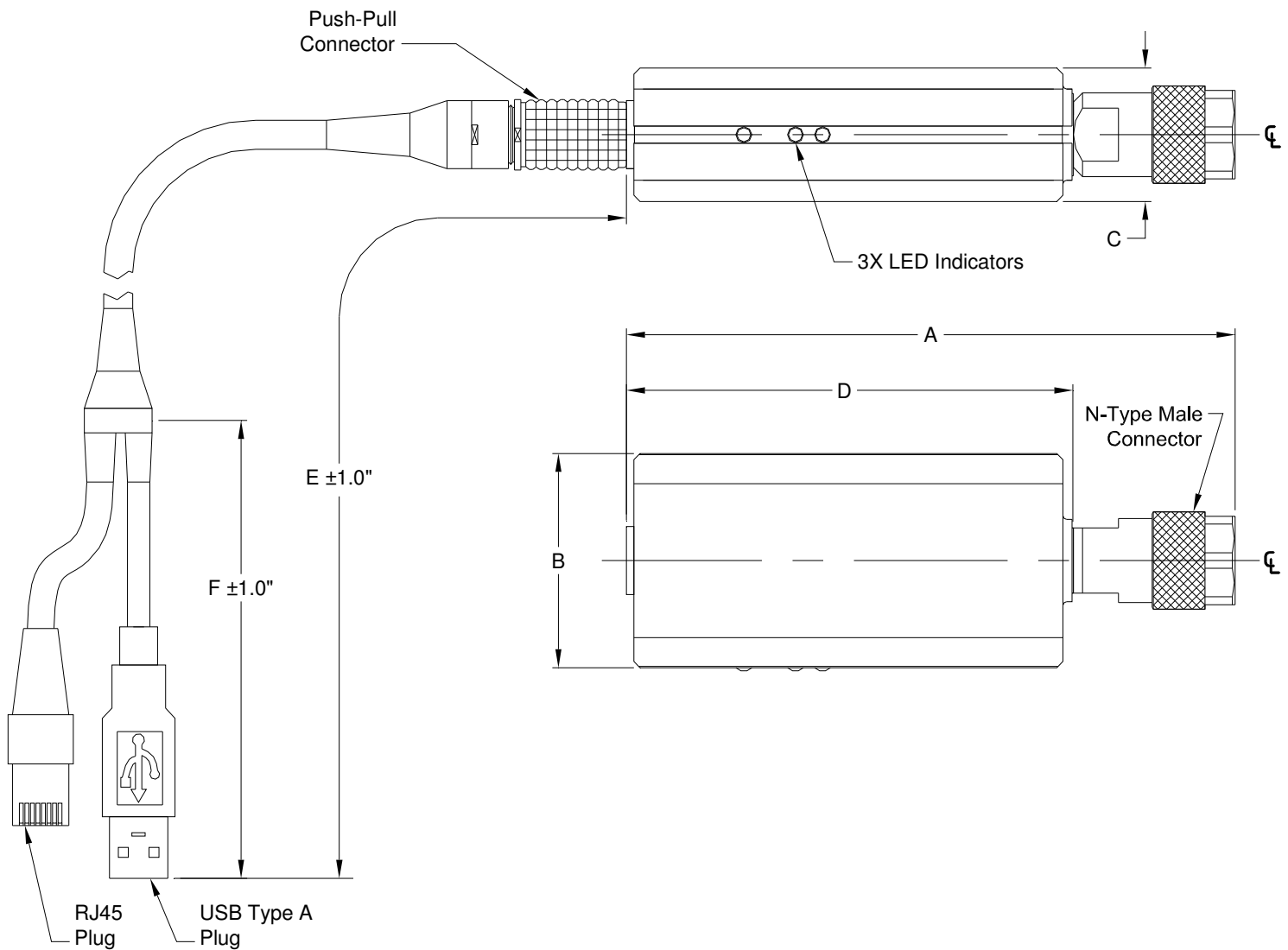

CASE#	A	B	C	D	E	F	WT. GRAMS
JL1941	4.95 (125.7)	1.74 (44.2)	1.08 (27.4)	3.63 (92.2)	80 (2032)	20 (508)	250

Dimensions are in inches (mm). Tolerances: 2 Pl. ± .03; 3 Pl. ± .015

Notes:

- Case material: Plastic.

Mini-Circuits®

INTERNET <http://www.minicircuits.com>

P.O. Box 350166, Brooklyn, New York 11235-0003 (718) 934-4500 Fax (718) 332-4661

Distribution Centers NORTH AMERICA 800-654-7949 • 417-335-5935 • Fax 417-335-5945 • EUROPE 44-1252-832600 • Fax 44-1252-837010

Mini-Circuits ISO 9001 & ISO 14001 Certified



Environmental Specifications **ENV50**

All Mini-Circuits products are manufactured under exacting quality assurance and control standards, and are capable of meeting published specifications after being subjected to any or all of the following physical and environmental test.

Specification	Test/Inspection Condition	Reference/Spec
Operating Temperature	-0° to 50° C Ambient Environment	Individual Model Data Sheet
Storage Temperature	-30° to 70° C Ambient Environment	Individual Model Data Sheet
Operating and Storage Humidity	5% to 85% RH (non-condensing)	Ambient
Bench Handling Test	Bench Top Tip 45° & Drop	MIL-PRF-28800F
Transit Drop Test	Free Fall Drop, 20 cm (7.9 inches)	MIL-PRF-28800F Class 3