

# Ceramic Directional Coupler

## DCW-30-272+

50Ω 30 dB Coupling 700 to 2700 MHz



CASE STYLE: JC0603C

### Maximum Ratings

Operating Temperature	-55°C to 100°C
Storage Temperature	-55°C to 100°C
Permanent damage may occur if any of these limits are exceeded.	

### Pad Connections

INPUT	1
OUTPUT	6
COUPLED	3
TERMINATION	4
GROUND	2,5

### Features

- Wideband, 700-2700 MHz
- Low insertion loss, 0.2 dB typ.
- Excellent return loss for input/output ports ideal for signal-tap
- Ultra small size, 0603 (1.6 x 0.8 mm)
- Temperature stable
- LTCC construction

### Applications

- GSM • LTE
- SMR • Wi-Fi
- ISM • UMTS

**+RoHS Compliant**  
The +Suffix identifies RoHS Compliance. See our web site for RoHS Compliance methodologies and qualifications

Available Tape and Reel at no extra cost  
Reel Size 7" Devices/Reel 20, 50, 100, 200, 500, 1000, 4000

### Outline Drawing

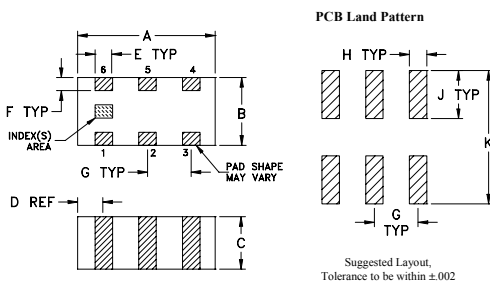

### Outline Dimensions (inch/mm)

A	B	C	D	E	F
.063	.031	.024	.012	.008	.006
1.60	0.79	0.61	0.30	0.20	0.15
G	H	J	K	wt	
.020	.010	.022	.053	grams	
0.51	0.25	0.56	1.35	0.005	

### Electrical Specifications at 25°C

Parameter	Frequency (MHz)	Min.	Typ.	Max.	Unit
Frequency Range		700		2700	MHz
Mainline Loss	700-2700	—	0.2	0.5	dB
Coupling	700-1000 1000-2700	—	30±1.5 28±1.5	—	dB
Coupling Flatness(±)	700-1000 1000-2700	—	1.5 1.5	—	dB
Directivity	700-2170 2170-2700	10 —	14 8	—	dB
Return Loss (Input)	700-2700	15	23	—	dB
Return Loss (Output)	700-2700	15	23	—	dB
Input Power <sup>1</sup>	700-2700	—	2	—	W

1. Derate linearly 1W at 100°C.

### Typical Performance Data

Frequency (MHz)	Mainline Loss (dB) In-Out	Coupling (dB) In-Cpl	Directivity (dB)	Return Loss (dB)		
				In	Out	Cpl
700	0.10	31.46	15.63	38.90	40.79	9.02
900	0.11	29.78	15.98	39.56	39.29	7.08
1000	0.11	29.16	16.26	39.65	38.74	6.32
1400	0.13	27.60	18.01	38.31	39.82	4.14
1800	0.15	27.06	19.17	37.16	38.66	2.85
1900	0.16	27.04	18.89	36.87	38.05	2.60
2170	0.17	27.15	16.54	33.21	34.18	2.08
2400	0.19	27.43	13.57	29.23	29.95	1.74
2600	0.21	27.86	10.92	25.74	26.09	1.49
2700	0.22	28.15	9.64	24.61	24.73	1.37

### Demo Board MCL P/N: TB-794+ Suggested PCB Layout (PL-440)

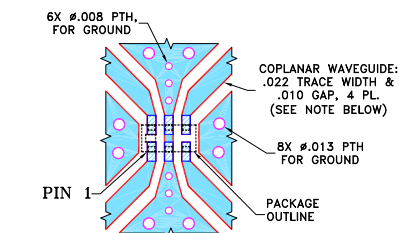

- NOTES:
1. COPLANAR WAVEGUIDE IS SHOWN FOR ROGERS RO4350B WITH DIELECTRIC THICKNESS .010" ± .001". COPPER: 1/2 OZ. EACH SIDE. FOR OTHER MATERIALS TRACE WIDTH AND GAP MAY NEED TO BE MODIFIED.
  2. BOTTOM SIDE OF THE PCB IS CONTINUOUS GROUND PLANE.
- DENOTES PCB COPPER LAYOUT WITH SMOBC (SOLDER MASK OVER BARE COPPER).  
■ DENOTES COPPER LAND PATTERN FREE OF SOLDER MASK.

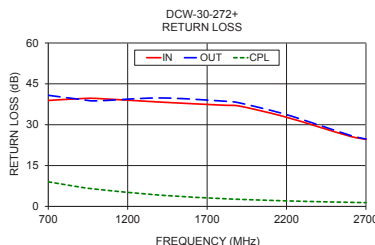
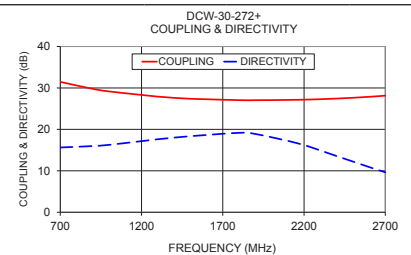
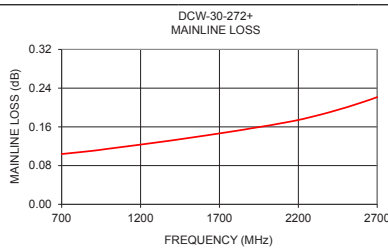

### Electrical Schematic

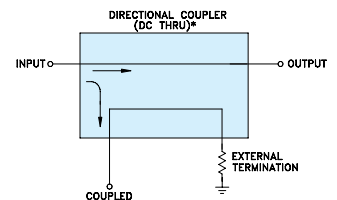

\* ELECTRICAL SCHEMATIC FOR DIRECTIONAL COUPLERS REQUIRING EXTERNAL TERMINATION THAT IS DESIGNED WITHOUT INTERNAL TRANSFORMERS.

### Notes

- Performance and quality attributes and conditions not expressly stated in this specification document are intended to be excluded and do not form a part of this specification document.
- Electrical specifications and performance data contained in this specification document are based on Mini-Circuit's applicable established test performance criteria and measurement instructions.
- The parts covered by this specification document are subject to Mini-Circuits standard limited warranty and terms and conditions (collectively, "Standard Terms"); Purchasers of this part are entitled to the rights and benefits contained therein. For a full statement of the Standard Terms and the exclusive rights and remedies thereunder, please visit Mini-Circuits' website at [www.minicircuits.com/MCLStore/terms.jsp](http://www.minicircuits.com/MCLStore/terms.jsp)



www.minicircuits.com P.O. Box 350166, Brooklyn, NY 11235-0003 (718) 934-4500 sales@minicircuits.com

REV. A  
M151107  
ED-16419/17  
DCW-30-272+  
MY/CP/AM  
150702  
Page 1 of 1

## Typical Performance Data

FREQUENCY (MHz)	INSERTION LOSS (dB)	COUPLING (dB)	DIRECTIVITY (dB)	RETURN LOSS (dB)		
				IN	OUT	CPL
250	0.08	39.71	15.11	43.66	41.63	17.87
300	0.09	38.14	15.32	41.84	42.13	16.27
350	0.09	36.86	15.46	41.38	42.18	14.86
400	0.09	35.76	15.31	41.49	40.41	13.69
450	0.09	34.83	15.38	41.97	40.62	12.71
500	0.09	34.01	15.34	40.44	41.47	11.80
550	0.10	33.25	15.32	40.07	40.47	10.98
600	0.10	32.58	15.33	41.15	39.54	10.28
650	0.10	31.99	15.43	40.18	39.58	9.65
700	0.10	31.46	15.63	38.90	40.79	9.02
750	0.10	30.98	15.65	39.52	39.78	8.46
800	0.11	30.54	15.68	40.27	39.26	7.98
850	0.11	30.14	15.83	39.49	39.46	7.53
900	0.11	29.78	15.98	39.56	39.29	7.08
950	0.11	29.45	16.01	40.00	38.76	6.68
1000	0.11	29.16	16.26	39.65	38.74	6.32
1050	0.12	28.88	16.44	39.42	39.18	5.99
1100	0.12	28.63	16.55	40.15	38.46	5.67
1150	0.12	28.41	16.75	39.39	38.39	5.38
1200	0.12	28.22	17.03	38.64	39.42	5.10
1250	0.12	28.04	17.23	39.10	39.31	4.83
1300	0.13	27.88	17.34	39.53	38.25	4.59
1350	0.13	27.73	17.69	38.74	38.98	4.36
1400	0.13	27.60	18.01	38.31	39.82	4.14
1450	0.13	27.49	18.13	39.17	38.89	3.95
1500	0.14	27.38	18.30	39.45	38.54	3.76
1550	0.14	27.31	18.60	38.09	39.26	3.58
1600	0.14	27.24	18.87	37.99	39.38	3.42
1650	0.14	27.17	18.97	39.03	38.17	3.26
1700	0.15	27.13	19.03	39.15	38.37	3.10
1750	0.15	27.10	19.13	37.59	39.17	2.97
1800	0.15	27.06	19.17	37.16	38.66	2.85
1850	0.16	27.04	19.03	37.25	38.49	2.73
1900	0.16	27.04	18.89	36.87	38.05	2.60
1950	0.16	27.05	18.66	36.08	37.32	2.48
2000	0.16	27.04	18.27	35.89	37.09	2.40
2050	0.16	27.06	17.84	35.18	36.48	2.30
2100	0.17	27.10	17.35	34.03	35.16	2.20
2150	0.17	27.13	16.82	33.41	34.25	2.11
2170	0.17	27.15	16.54	33.21	34.18	2.08
2200	0.17	27.16	16.15	32.79	33.84	2.04
2250	0.17	27.16	16.15	32.79	33.84	2.04
2300	0.18	27.30	14.96	30.52	31.31	1.86
2350	0.18	27.30	14.96	30.52	31.31	1.86
2400	0.19	27.43	13.57	29.23	29.95	1.74
2450	0.19	27.43	13.57	29.23	29.95	1.74
2500	0.20	27.63	12.30	27.49	27.87	1.60
2550	0.20	27.63	12.30	27.49	27.87	1.60
2600	0.21	27.86	10.92	25.74	26.09	1.49
2650	0.21	27.86	10.92	25.74	26.09	1.49
2700	0.22	28.15	9.64	24.61	24.73	1.37
2800	0.24	28.46	8.34	22.84	22.92	1.28
2900	0.25	28.84	7.02	22.01	21.94	1.19
3000	0.27	29.31	5.77	20.36	20.29	1.11

# Directional Coupler

# DCW-30-272+

## Typical Performance Curves

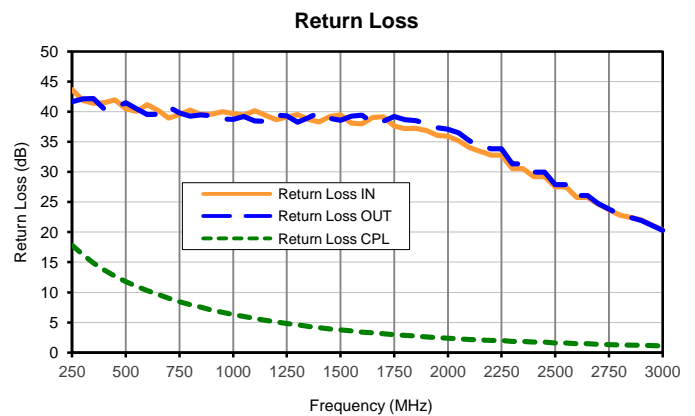
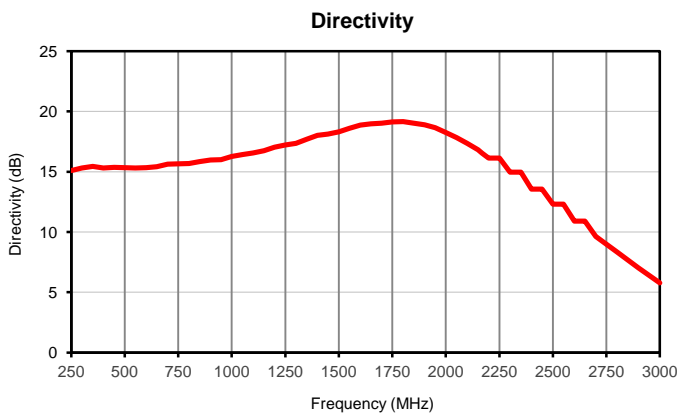
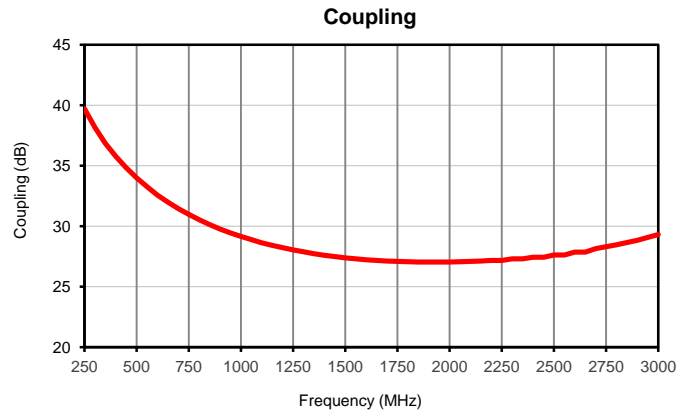
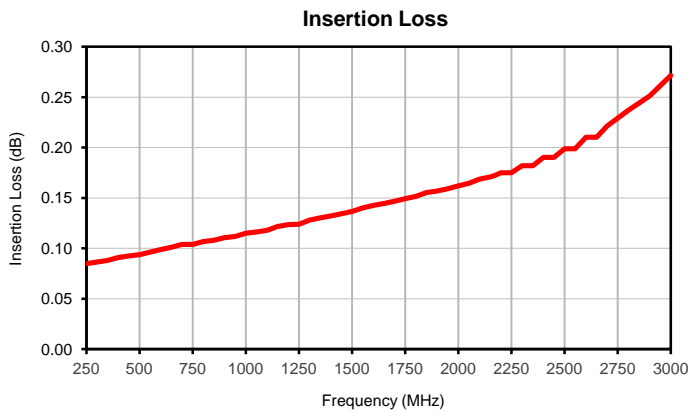

### Outline Dimensions

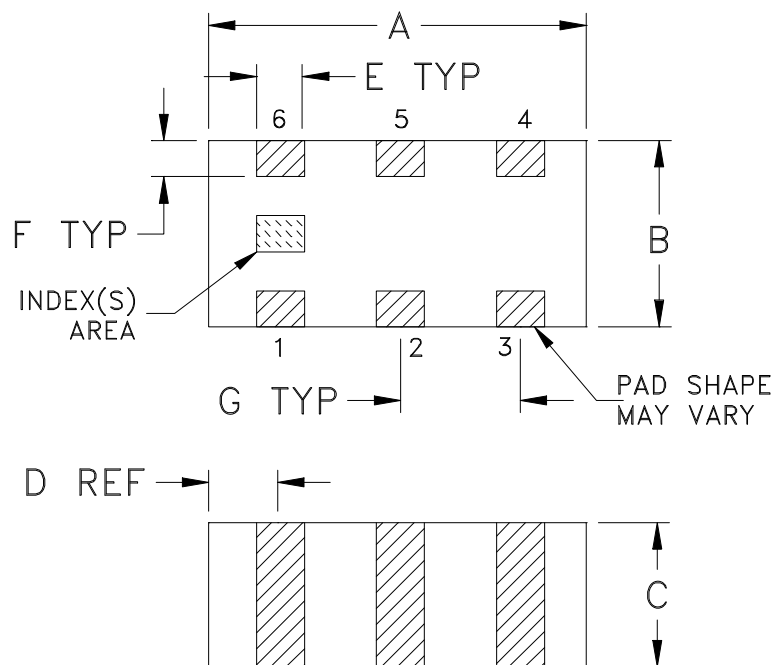

### PCB Land Pattern

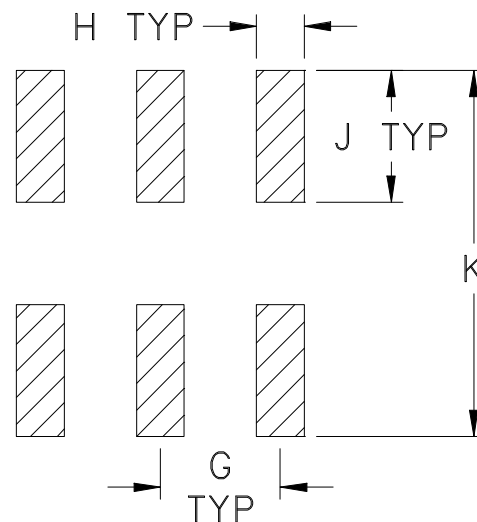

Suggested Layout,  
Tolerance to be within  $\pm .002$

CASE #	A	B	C	D	E	F	G	H	J	K	WT. GRAM
JC0603C	.063 (1.60)	.031 (0.80)	.024 (0.60)	.012 (0.30)	.008 (0.20)	.006 (0.15)	.020 (0.50)	.010 (0.25)	.022 (0.55)	0.053 (1.35)	.005

Dimensions are in inches (mm). Tolerances: 2 Pl.  $\pm .01$ ; 3 Pl.  $\pm .005$

#### Notes:

- Open style, ceramic base.
- Termination finish:  
For RoHS Case Styles: Tin plate over Nickel plate. All models, (+) suffix.

# Tape & Reel Packaging TR-F114

## DEVICE ORIENTATION IN T&R

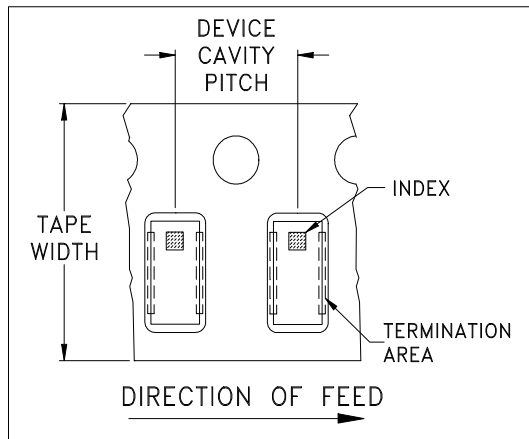

ILLUSTRATION 1

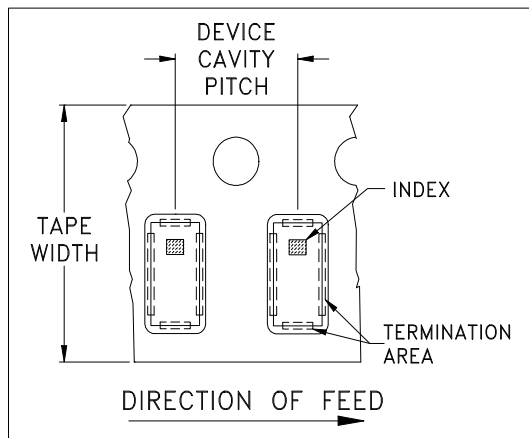

ILLUSTRATION 2

Tape Width, mm	Device Cavity Pitch, mm	Reel Size, inches	Devices per Reel	
8	4	7	Small quantity standards (see note)	20
				50
				100
				200
				500
			Standard	4000

Note: Please Consult individual model data sheet to determine device per reel availability.

Mini-Circuits carrier tape materials provide protection from ESD (Electro-Static Discharge) during handling and transportation. Tapes are static dissipative and comply with industry standards EIA-481/EIA-541.

Go to: [www.minicircuits.com/pages/pdfs/tape.pdf](http://www.minicircuits.com/pages/pdfs/tape.pdf)



INTERNET <http://www.minicircuits.com>

P.O. Box 350166, Brooklyn, New York 11235-0003 (718) 934-4500 Fax (718) 332-4661

Distribution Centers NORTH AMERICA 800-654-7949 • 417-335-5935 • Fax 417-335-5945 • EUROPE 44-1252-832600 • Fax 44-1252-837010

Mini-Circuits ISO 9001 & ISO 14001 Certified

THIRD ANGLE PROJECTION

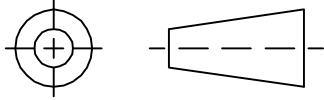

REVISIONS

REV	ECN No.	DESCRIPTION	DATE	DR	AUTH
OR	M148537	NEW RELEASE	10/14/14	GF	MY

**SUGGESTED MOUNTING CONFIGURATION  
FOR JC0603C CASE STYLE, "06DC12" PIN CODE**

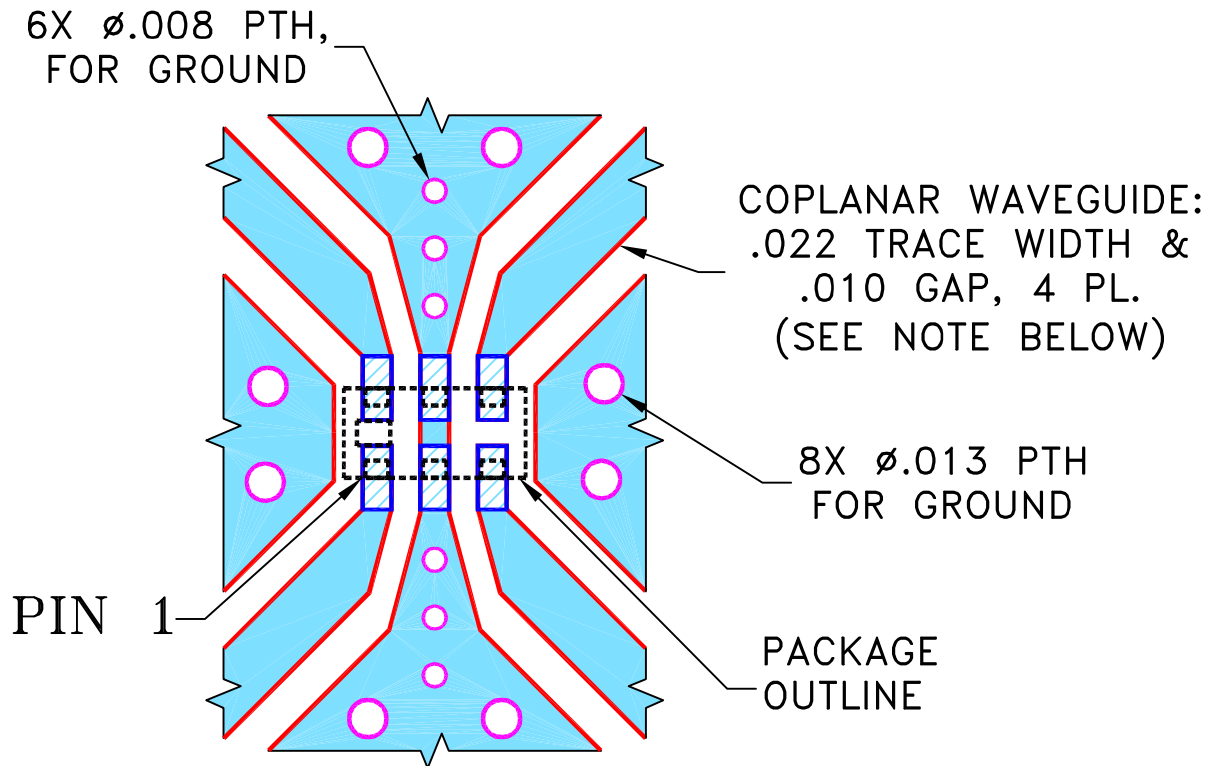

**NOTES:**

1. COPLANAR WAVEGUIDE IS SHOWN FOR ROGERS RO4350B WITH DIELECTRIC THICKNESS .010" ± .001". COPPER: 1/2 OZ. EACH SIDE. FOR OTHER MATERIALS TRACE WIDTH AND GAP MAY NEED TO BE MODIFIED.
2. BOTTOM SIDE OF THE PCB IS CONTINUOUS GROUND PLANE.

 DENOTES PCB COPPER LAYOUT WITH SMOBC (SOLDER MASK OVER BARE COPPER).

 DENOTES COPPER LAND PATTERN FREE OF SOLDER MASK.

UNLESS OTHERWISE SPECIFIED	INITIALS	DATE
DRAWN	GF	10/07/14
CHECKED	AV	10/14/14
APPROVED	MY	10/14/14

 **Mini-Circuits®** 13 Neptune Avenue  
Brooklyn NY 11235

**PL, 06DC12, JC0603C, TB-794+**

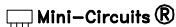
 Mini-Circuits®  
THIS DOCUMENT AND ITS CONTENTS ARE THE PROPERTY OF MINI-CIRCUITS. EXCEPT FOR USE EXPRESSLY GRANTED, IN WRITING, TO ITS VENDORS, VENDEE AND THE UNITED STATES GOVERNMENT, MINI-CIRCUITS RESERVES ALL PROPRIETARY DESIGN, USE, MANUFACTURING AND REPRODUCTION RIGHTS THERETO. THESE CONTENTS SHALL NOT BE USED, DUPLICATED OR DISCLOSED TO ANY OUTSIDE PARTY, IN WHOLE OR IN PART, WITHOUT WRITTEN PERMISSION OF MINI-CIRCUITS.

SIZE	CODE IDENT	DRAWING NO:	REV:
A	15542	98-PL-440	OR
FILE:	98PL440	SCALE: 15:1	SHEET: 1 OF 1

# Evaluation Board and Circuit

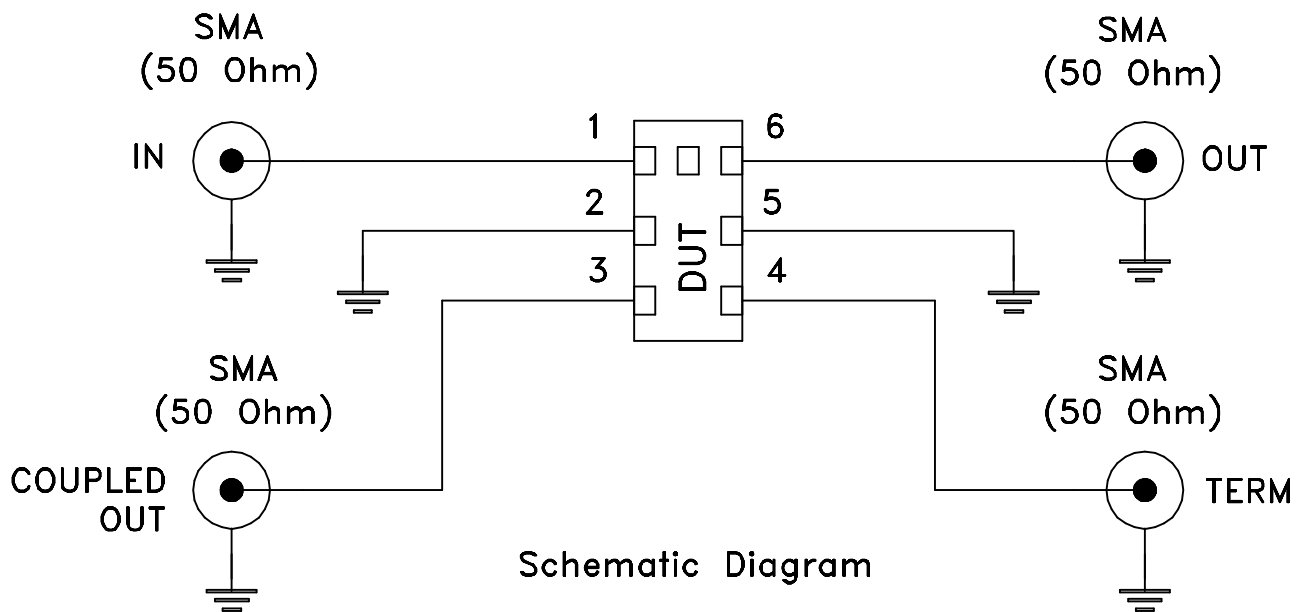
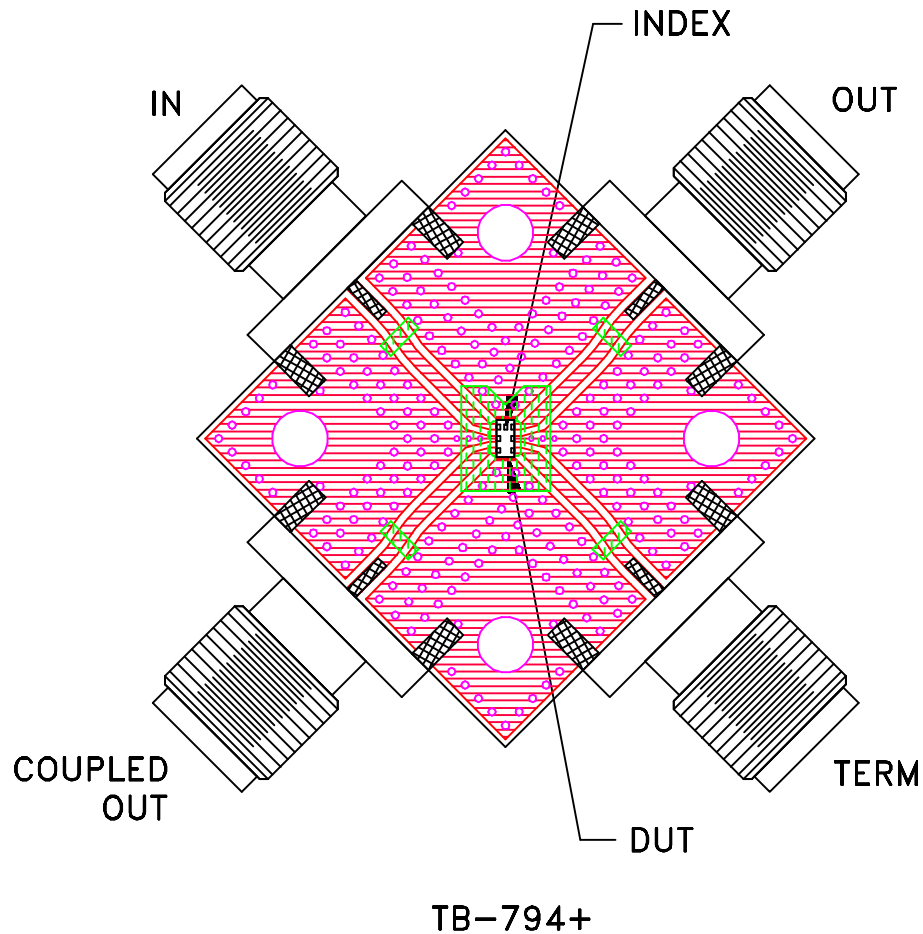

**Notes:**

1. 50 Ohm SMA Female connectors.
2. PCB Material: R04350 or equivalent,  
Dielectric Constant=3.5, Thickness=.010 inch.

**Mini-Circuits®**

All Mini-Circuits products are manufactured under exacting quality assurance and control standards, and are capable of meeting published specifications after being subjected to any or all of the following physical and environmental test.

Specification	Test/Inspection Condition	Reference/Spec
Operating Temperature	-55° to 100°C Ambient Environment	Individual Model Data Sheet
Storage Temperature	-55° to 100° C Ambient Environment	Individual Model Data Sheet
Humidity	90 to 95% RH, 240 hours, 50°C	MIL-STD-202, Method 103, Condition A, Except 50°C and end-point electrical test done within 12 hours
Solder Reflow Heat	Sn-Pb Eutetic Process: 225°C peak Pb-Free Process 245° - 250°C peak	J-STD-020, Table 4-1, 4-2 and 5-2, Figure 5-1
Solderability	10X Magnification	J-STD-002, Para 4.2.5, Test S, 95% Coverage
Vibration (High Frequency)	20g peak, 10-2000 Hz, 12 times in each of three perpendicular directions (total 36)	MIL-STD-202, Method 204, Condition D
Mechanical Shock	50g, 11 ms, 1/2-sine, 18 shocks: 3 each direction, each of 3 axes	MIL-STD-202, Method 213, Condition A